

HDC302x High-Accuracy, Low-Power, Digital Humidity and Temperature Sensor With Ultra-Low Drift

1 Features

- Relative humidity (RH) sensor:
 - Operating range: 0% to 100%
 - Accuracy: $\pm 1.5\%$ typical
 - Drift Correction: reduces offset to return device to within accuracy specification
 - Long-term drift: 0.21%RH/yr
 - Condensation protection with integrated heater
- Temperature sensor:
 - Operating range: -40°C to 125°C
 - Accuracy: $\pm 0.1^{\circ}\text{C}$ typical
- NIST traceability: Relative humidity & temperature
- Low power: average current 0.7 μA
- I²C interface compatibility up to 1-MHz speeds
 - Four selectable I²C addresses
 - Command/data protection through CRC checksum
- Supply voltage: 1.62 V to 5.50 V
- Available auto measurement mode
- Programmable interrupts
- Programmable measurement calibration
- Factory-installed polyimide tape assembly cover
- Factory-installed IP67 rated environmental cover

2 Applications

- Washer & dryer
- Refrigerator & freezer
- Industrial transport
- Cold Chain asset tracking & data logger
- IoT environmental sensors
- Air quality and gas detection
- Humidifier/dehumidifier
- Thermostat
- CPAP and ventilator
- Water leak detector
- IP Camera

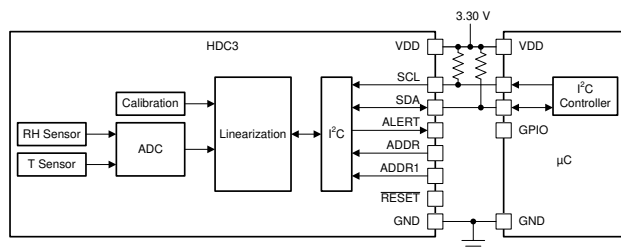

Typical Application

3 Description

The HDC302x is an integrated capacitive based relative humidity (RH) and temperature sensor, which provides high accuracy measurements over a wide supply range (1.62 V – 5.5 V), along with ultra-low power consumption in a compact 2.5-mm × 2.5-mm package. Both the temperature and humidity sensors are 100% tested and trimmed on a production setup that is NIST traceable and verified with equipment that is calibrated to ISO/IEC 17025 standards.

Drift Correction reduces RH sensor offset due to aging, exposure to extreme operating conditions, and contaminants to return device to within accuracy specifications. For battery IoT applications, auto measurement mode and ALERT feature enable low system power by maximizing MCU sleep time. There are four different I²C addresses that support speeds up to 1 MHz. A heating element is available to dissipate condensation and moisture.

The HDC3020 comes in an open cavity package without a protective cover. Two device variants have a cover option to protect the open cavity RH sensor: HDC3021 and HDC3022. HDC3021 has removable protective tape to allow conformal coatings and PCB wash. HDC3022 has a permanent IP67 filter membrane cover to protect against dust and water.

Device Information

PART NUMBER	PACKAGE ⁽¹⁾	BODY SIZE (NOM)
HDC3020 HDC3021 ⁽²⁾ HDC3022 ⁽²⁾	WSON (8)	2.50 mm × 2.50 mm

- For all available packages, see the orderable addendum at the end of the data sheet.
- Preview only.

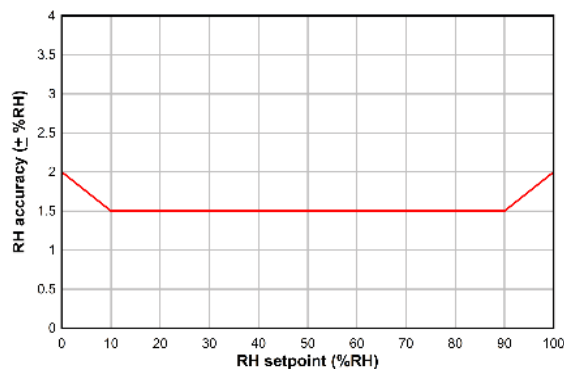

Typical RH Accuracy vs. RH Setpoint (T_A = 25°C)



Table of Contents

1 Features	1	8 Application and Implementation	29
2 Applications	1	8.1 Application Information.....	29
3 Description	1	8.2 Typical Application.....	29
4 Revision History	2	9 Power Supply Recommendations	32
5 Pin Configuration and Functions	3	10 Layout	32
6 Specifications	4	10.1 Layout Guidelines.....	32
6.1 Absolute Maximum Ratings	4	10.2 Layout Example.....	33
6.2 ESD Ratings	4	10.3 Storage and PCB Assembly.....	33
6.3 Recommended Operating Conditions	4	11 Device and Documentation Support	35
6.4 Thermal Information	4	11.1 Documentation Support.....	35
6.5 Electrical Characteristics	5	11.2 Receiving Notification of Documentation Updates..	35
6.6 Switching Characteristics	7	11.3 Support Resources.....	35
6.7 Timing Diagram.....	7	11.4 Trademarks.....	35
6.8 Typical Characteristics.....	8	11.5 Electrostatic Discharge Caution.....	35
7 Detailed Description	9	11.6 Glossary.....	35
7.1 Overview.....	9	12 Mechanical, Packaging, and Orderable	
7.2 Functional Block Diagram.....	9	Information	35
7.3 Feature Description.....	9	12.1 Package Option Addendum.....	45
7.4 Device Functional Modes.....	12	12.2 Tape and Reel Information.....	47
7.5 Programming.....	12		

4 Revision History

DATE	VERSION	NOTES
June 2021	*	Initial release.

5 Pin Configuration and Functions

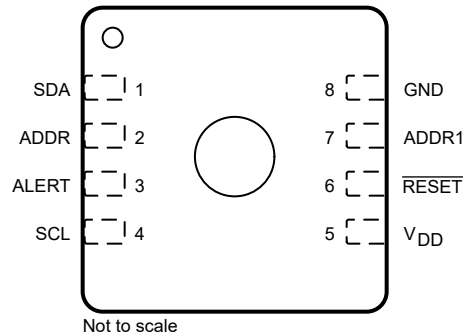

1. DEF package has a transparent top.
2. HDC3021 DEH and HDC3022 DEJ packages are preview only.

Figure 5-1. HDC302x DEF, DEH, or DEJ Package 8-Pin WSON Top View

Table 5-1. Pin Functions

PIN		TYPE ⁽¹⁾	DESCRIPTION
NAME	NO.		
V _{DD}	5	P	Supply Voltage. From 1.62 V to 5.50 V.
GND	8	G	Ground
SCL	4	I	Serial clock line for I ² C, open-drain; requires a pullup resistor to V _{DD} .
SDA	1	I/O	Serial data line for I ² C, open-drain; requires a pullup resistor to V _{DD} .
ADDR	2	I	I ² C Device Address Pin. For device addresses 0x44 and 0x45, ADDR1 voltage must be below maximum V _{IL} or left floating. 0x44 requires ADDR voltage to be below maximum V _{IL} or left floating. 0x45 requires ADDR voltage to be above minimum V _{IH} .
ADDR1	7	I	I ² C Device Address Pin. For device addresses 0x46 and 0x47, ADDR1 voltage must be above minimum V _{IH} . 0x46 requires ADDR voltage to be below maximum V _{IL} or left floating. 0x47 requires ADDR voltage to be above minimum V _{IH} .
RESET	6	I	Reset Pin. Active Low. If not used, leave floating or tie to V _{DD} .
ALERT	3	O	Interrupt Pin to drive high impedance loads. Push-Pull Output. If not used, must be left floating.

- (1) Type:
 G = Ground
 I = Input
 O = Output
 P = Power

6 Specifications

6.1 Absolute Maximum Ratings

over operating free-air temperature range (unless otherwise noted)⁽¹⁾

		MIN	MAX	UNIT
V _{DD}	Applied Voltage on VDD pin	-0.3	6.0	V
SCL	Applied Voltage on SCL pin	-0.3	6.0	V
SDA	Applied Voltage on SDA pin	-0.3	6.0	V
ADDR	Applied Voltage on ADDR pin	-0.3	6.0	V
ADDR1	Applied Voltage on ADDR1 pin	-0.3	V _{DD} + 0.3	V
ALERT	Applied Voltage on ALERT pin	-0.3	V _{DD} + 0.3	V
RESET	Applied Voltage on RESET pin	-0.3	V _{DD} + 0.3	V
T _J	Junction temperature	-55	150	°C
T _{stg}	Storage temperature	-65	150	°C

- (1) Stresses beyond those listed under *Absolute Maximum Ratings* may cause permanent damage to the device. These are stress ratings only, which do not imply functional operation of the device at these or any other conditions beyond those indicated under *Recommended Operating Conditions*. Exposure to absolute-maximum-rated conditions for extended periods may affect device reliability.

6.2 ESD Ratings

			VALUE	UNIT	
V _(ESD)	Electrostatic discharge	Human body model (HBM), per ANSI/ESDA/JEDEC JS-001 ⁽¹⁾	±2000	V	
		Charged device model (CDM), per JEDEC specification JESD22-C101 ⁽²⁾	All Pins		±500
		Charged device model (CDM), per JEDEC specification JESD22-C101 ⁽²⁾	Corner Pins		±750

- (1) JEDEC document JEP155 states that 500-V HBM allows safe manufacturing with a standard ESD control process
(2) JEDEC document JEP157 states that 250-V CDM allows safe manufacturing with a standard ESD control process

6.3 Recommended Operating Conditions

PARAMETER		MIN	MAX	UNIT
V _{DD}	Supply voltage	1.62	5.5	V
T _{TEMP}	Temperature Sensor - Operating free-air temperature	-40	125	°C
T _{RH}	Relative Humidity Sensor - Operating free-air temperature	-20	70	°C
T _{HEATER}	Integrated Heater for condensation removal - Operating free-air temperature ⁽¹⁾	-40	60	°C
RH _{OR}	Relative Humidity Sensor Operating Range (Non-condensing) ⁽¹⁾	0	100	%RH

- (1) Prolonged operation outside the recommended temperature operating conditions and/or at >80%RH with temperature in the higher recommended operating range can result in a shift of sensor reading, with slow recovery time. See [Exposure to High Temperature and High Humidity Conditions](#) for more details.

6.4 Thermal Information

THERMAL METRIC ⁽¹⁾		HDC3x	UNIT
		DEF, DEH, and DEJ	
		8 PINS	
R _{θJA}	Junction-to-ambient thermal resistance	84.9	°C/W
R _{θJC(top)}	Junction-to-case (top) thermal resistance ⁽²⁾	N/A	°C/W
R _{θJB}	Junction-to-board thermal resistance	52.0	°C/W
Ψ _{JT}	Junction-to-top characterization parameter ⁽²⁾	N/A	°C/W

THERMAL METRIC ⁽¹⁾		HDC3x	UNIT
		DEF, DEH, and DEJ	
		8 PINS	
Ψ_{JB}	Junction-to-board characterization parameter	51.7	°C/W
$R_{\theta JC(bot)}$	Junction-to-case (bottom) thermal resistance	30.4	°C/W

- (1) For more information about traditional and new thermal metrics, see the [Semiconductor and IC Package Thermal Metrics](#) application report.
- (2) JEDEC standard JESD51-X specifies this measurement at the center position on the top surface of the package. Due to the location of the cavity opening at the center position, this measurement is not applicable.

6.5 Electrical Characteristics

$T_A = -40^\circ\text{C}$ to 125°C , $V_{DD} = 1.62\text{V}$ to 5.50V (unless otherwise noted), Typical Specifications are $T_A = 25^\circ\text{C}$, $V_{DD} = 1.8\text{V}$ unless otherwise noted

PARAMETER		TEST CONDITIONS	MIN	TYP	MAX	UNIT
Current Consumption						
I_{DD_ACTIVE}	Active Current ⁽¹⁾	Low Power Mode 0 (lowest noise)		125	TBD	μA
		Low Power Mode 1		TBD		
		Low Power Mode 2		TBD		
		Low Power Mode 3		100	TBD	
I_{DD_SLEEP}	Sleep Current ⁽¹⁾	No Active Measurement trigger on demand mode		0.4	TBD	μA
		No Active Measurement, auto measurement mode		0.55	TBD	
$I_{DD_AVG_EQN}$	Averaged Current Equation	measurement freq = numbers of samples per second		(9)		
I_{DD_AVG}	Averaged Current ^{(1) (2)}	Low Power Mode 0 (lowest noise) Averaged at 1 sample per second		2.0	TBD	μA
		Low Power Mode 1 Averaged at 1 sample per second		1.2	TBD	
		Low Power Mode 2 Averaged at 1 sample per second		1.0	TBD	
		Low Power Mode 3 (lowest power) Averaged at 1 sample per second		0.9	TBD	
		Low Power Mode 3 (lowest power) Averaged at 1 sample every two seconds		0.7	TBD	
I_{HEATER}	Heater Current (Condensation Removal)	$T_{HEATER} - T_{AMBIENT} = 20^\circ\text{C}$. $V_{DD} = 3.3\text{V}$ for Typical Value		30	TBD	mA
Sensor Timing						
t_{meas}	Measurement Duration ⁽⁸⁾	Low Power Mode 0 (lowest noise)		12.0	TBD	ms
		Low Power Mode 1		7.0	TBD	
		Low Power Mode 2		4.5	TBD	
		Low Power Mode 3 (lowest power)		3.3	TBD	
Sensor _{PU} R	Power Up Ready	Sensor ready once $V_{DD} \geq 1.62\text{V}$ $T_A = 25^\circ\text{C}$		0.5	1	ms
		Sensor ready once $V_{DD} \geq 1.62\text{V}$			1.5	
Sensor _{SR} R	Soft Reset Ready	Sensor ready once Soft Rest Command received $T_A = 25^\circ\text{C}$		0.5	1	ms
		Sensor ready once Soft Rest Command received			1.5	
Relative Humidity Sensor						
RH _{ACC}	Accuracy ^{(3) (4)}	$T_A = 25^\circ\text{C}$, 10% to 90% RH		± 1.5	± 2	%RH

$T_A = -40^{\circ}\text{C}$ to 125°C , $V_{DD} = 1.62\text{V}$ to 5.50V (unless otherwise noted), Typical Specifications are $T_A = 25^{\circ}\text{C}$, $V_{DD} = 1.8\text{V}$ unless otherwise noted

PARAMETER		TEST CONDITIONS	MIN	TYP	MAX	UNIT
RH _{REP}	Repeatability	at ambient room temp $T_A = 25^{\circ}\text{C}$, 10% to 90% RH Low Power Mode 0 (lowest noise)		±0.02		%RH
		$T_A = 25^{\circ}\text{C}$, 10% to 90% RH Low Power Mode 1		TBD		
		$T_A = 25^{\circ}\text{C}$, 10% to 90% RH Low Power Mode 2		TBD		
		$T_A = 25^{\circ}\text{C}$, 10% to 90% RH Low Power Mode 3 (lowest power)		TBD		
RH _{HYS}	Hysteresis ⁽⁵⁾	$T_A = 25^{\circ}\text{C}$, 10% to 90% RH		±1		%RH
RH _{RT}	Response Time ^{(6) (7)}	$T_A = 25^{\circ}\text{C}$, 10% to 90% RH $t_{63\%}$ step.		4		s
RH _{LTD}	Long-term Drift ⁽⁴⁾			0.21		%RH/yr
Temperature Sensor						
TEMP _{ACC}	Accuracy	$-20^{\circ}\text{C} \leq T_A \leq 60^{\circ}\text{C}$		±0.1	±0.3	°C
		$-40^{\circ}\text{C} \leq T_A < -20^{\circ}\text{C}$ or $60^{\circ}\text{C} < T_A \leq 125^{\circ}\text{C}$		±0.2	±0.4	
TEMP _{REP}	Repeatability	Low Power Mode 0 (lowest noise)		±0.04		°C
		Low Power Mode 1		TBD		
		Low Power Mode 2		TBD		
		Low Power Mode 3 (lowest power)		±0.07		
TEMP _{RT}	Response Time (in air) ^{(6) (7)}	$25^{\circ}\text{C} < T_A < 75^{\circ}\text{C}$ $t_{63\%}$ step		TBD		s
TEMP _{LTD}	Long Term Drift				±0.03	°C/yr
SCL, SDA Pins						
V _{IL}	LOW-level input voltage				0.3*V _{DD}	V
V _{IH}	HIGH-level input voltage		0.7*V _{DD}			V
V _{OL}	LOW-level output voltage	I _{OL} = 3 mA			0.4	V
Control Pins						
V _{OH_ALERT}	High-level Output Voltage - ALERT	I _{OH} = -100 μA	V _{DD} -0.2			V
V _{OL_ALERT}	Low-level Output Voltage - ALERT	I _{OL} = 100 μA			0.2	V
V _{IH_ADDR}	High Level Input Voltage - ADDR		0.7*V _{DD}			V
V _{IL_ADDR}	Low Level Input Voltage - ADDR			0.3*V _{DD}		V
V _{IH_ADDR1}	High Level Input Voltage - ADDR1		0.7*V _{DD}			V
V _{IL_ADDR1}	Low Level Input Voltage - ADDR1			0.3*V _{DD}		V
V _{IH_RESET}	High Level Input Voltage - RESET		0.7*V _{DD}			V
V _{IL_RESET}	Low Level Input Voltage - RESET			0.3*V _{DD}		V
I _{I_ADDR}	Input Leakage Current - ADDR	V _I = V _{DD} or GND	-1		1	μA
I _{I_ADDR1}	Input Leakage Current - ADDR1	V _I = V _{DD} or GND	-1		1	μA
EEPROM (T, RH offset)						
OS _{END}	Program Endurance		1000	50000		Cycles
OS _{RET}	Data Retention Time	100% Power-On hours	10	100		Years

- (1) Does not include I²C read/write communication or pullup resistor current through SCL and SDA
- (2) Average current consumption while conversion is in progress
- (3) Excludes hysteresis and long-term drift

- (4) Based on THB (temperature humidity bias) testing. Excludes the impact of dust, gas phase solvents and other contaminants such as vapors from packaging materials, adhesives, or tapes, etc.
- (5) The hysteresis value is the difference between the RH measurement in a rising and falling RH environment, at a specific RH point
- (6) Actual response times will vary dependent on system thermal mass and air-flow
- (7) Time for the RH output to change by 63% of the total RH change after a step change in environmental humidity
- (8) Measurement duration includes the time to measure RH plus Temp
- (9) $I_{DD_AVG_EQN} = \text{measurement freq} \times I_{DD_ACTIVE} \times t_{meas} + I_{sleep} \times (1 - (\text{measurement freq} \times t_{meas}))$

6.6 Switching Characteristics

$T_A = -40^\circ\text{C}$ to 125°C and $V_{DD} = 1.62\text{V}$ to 5.50V (unless otherwise noted)

PARAMETER		TEST CONDITIONS	MIN	TYP	MAX	UNIT
SCL, SDA PINS						
f_{SCL}	SCL clock frequency ⁽¹⁾		0		1	MHz
t_{HIGH}	High period of the SCL clock ⁽¹⁾		0.6			μs
t_{LOW}	LOW period of the SCL clock ⁽¹⁾		1.3			μs
$t_{SU,DAT}$	Setup Time: Data ⁽¹⁾		100			ns
$t_{HD,DAT}$	Hold Time: Data ⁽¹⁾		0			μs
$t_{SU,STA}$	Set-up time: Repeated START condition ⁽¹⁾		0.6			μs
$t_{HD,STA}$	Hold time: Repeated START condition ^{(1) (2)}		0.6			μs
$t_{SU,STO}$	Set-up time: STOP condition ⁽¹⁾		0.6			μs
$t_{R,SCL}$	Rise Time: SCL ⁽¹⁾				300	ns
$t_{R,SDA}$	Rise Time: SDA ⁽¹⁾				300	ns
$t_{F,SCL}$	Fall Time: SCL ⁽¹⁾		$20 \times (V_{DD}/5.5\text{V})$		300	ns
$t_{F,SDA}$	Fall Time: SDA ⁽¹⁾		$20 \times (V_{DD}/5.5\text{V})$		300	ns
t_{BUF}	Bus free time between a STOP and START condition ⁽¹⁾		1.3			μs
$t_{VD,DAT}$	Data valid time ^{(1) (3)}				0.9	μs
$t_{VD,ACK}$	Data valid acknowledge time ^{(1) (4)}				0.9	μs
RESET						
t_{RESET_NPW}	Negative pulse width to trigger hard reset		1			μs
EEPROM (T, RH OFFSET)						
t_{OS_PROG}	Offset Programming Time			10	15	ms

- (1) Guaranteed by design/characterization; not production tested
- (2) After this period, the first clock pulse is generated
- (3) Time for data signal from SCL low to SDA output (high to low, depending on which is worse)
- (4) Time for acknowledgement signal from SCL low to SDA output (high or low, depending on which is worse)

6.7 Timing Diagram

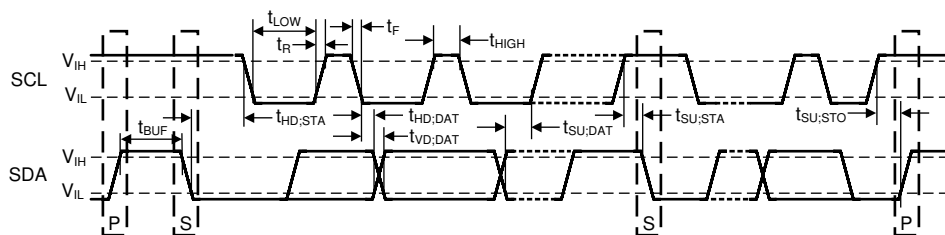

Figure 6-1. HDC302x I²C Timing Diagram

6.8 Typical Characteristics

Unless otherwise noted. $T_A = 25^\circ\text{C}$, $V_{DD} = 1.80\text{ V}$.

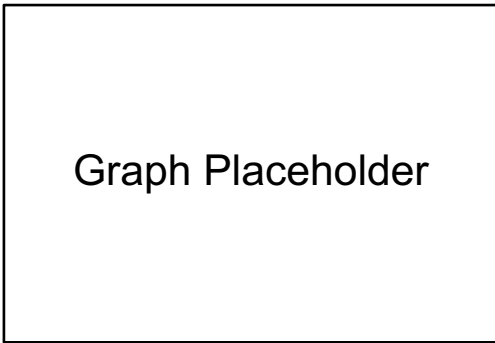

Figure 6-2. RH Accuracy vs. RH Set Point

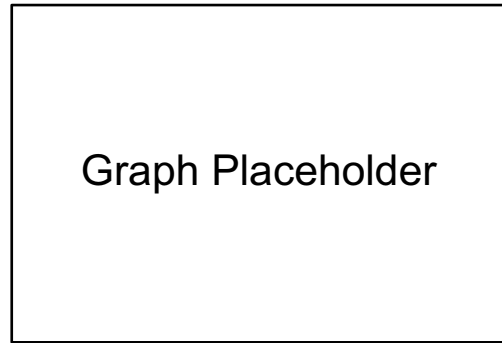

Figure 6-3. T Accuracy vs. T Set Point

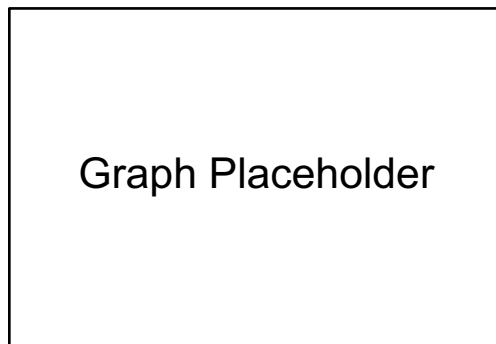

Figure 6-4. RH Accuracy vs. T Set Point

ADVANCE INFORMATION

7 Detailed Description

7.1 Overview

The HDC302x is an integrated digital interface sensor that incorporates both humidity-sensing and temperature-sensing elements, an analog-to-digital converter, calibration memory, and an I²C compatible interface in a 2.50-mm × 2.50-mm, 8-pin WSON package. The HDC302x also provides excellent measurement accuracy.

The HDC302x measures relative humidity through variations in the capacitance of a polymer dielectric. As with most relative humidity sensors that include this type of technology, care must be taken to ensure optimal device performance for the sensing element. This includes:

- Follow the correct storage and handling procedures during board assembly. See [HDC3x Silicon User's Guide](#) (SNAU265) for these guidelines.
- Protect the sensor from contaminants during board assembly and operation.
- Reduce prolonged exposure to both high temperature and humidity extremes that may impact sensor accuracy.
- Follow the correct layout guidelines for best performance. See [Optimizing Placement and Routing for Humidity Sensors](#) (SNAA297) for these guidelines.

7.2 Functional Block Diagram

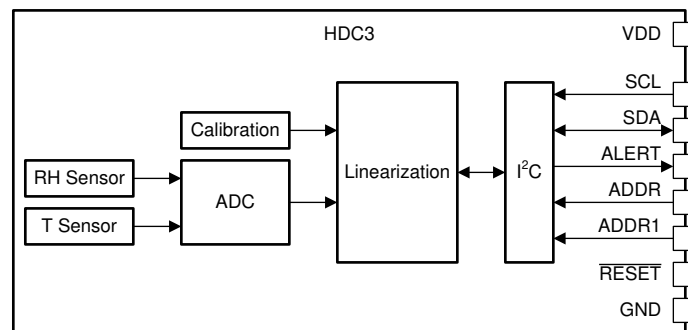

7.3 Feature Description

7.3.1 Factory Installed Polyimide Tape

The HDC3021 has a polyimide tape to cover the opening of the humidity sensor element. The tape protects the humidity sensor element from pollutants that can be produced as part of the manufacturing process, such as SMT assembly, printed circuit board (PCB) wash, and conformal coating. The tape must be removed after the final stages of assembly for accurate measurement of relative humidity in the ambient environment. The tape can withstand at least three standard reflow cycles.

To remove the polyimide tape from the humidity sensor element, TI recommends to use a ESD-safe tweezer to grip the adhesive-free tab in the top right corner, and slowly peel the adhesive from the top-right corner towards the bottom-left corner in an upward direction (as opposed to across the surface). This will help to reduce the risk of scratching the humidity sensor element.

7.3.2 Factory Installed IP67 Protection Cover

HDC3022 has an IP67 rated PTFE permanent filter to cover the opening of the humidity sensor element. The cover is a hydrophobic microporous PTFE foil that protects the humidity sensor element against dust and water according to IP67 specifications. The cover is designed to adhere to the package over lifetime operation while maintaining the same response time as a sensor without the membrane. The cover has a filtration efficiency of 99.99% down to a particle size of 100 nm.

7.3.3 Measurement of Relative Humidity and Temperature

The HDC302x supports measurements of Relative Humidity and Temperature. The supported Relative Humidity Range is 0% to 100% and the supported Temperature Range is from –40°C to 125°C. Each measurement is represented in a 16-bit format, and the conversion formulas are documented below:

$$RH_{(\%)} = 100 \times \left[(RH_{HDC3020}) \times \left(\frac{1}{2^{16} - 1} \right) \right] \quad (1)$$

$$T_{(C)} = -45 + \left[(175) \times \left(\frac{T_{HDC3020}}{2^{16} - 1} \right) \right] \quad (2)$$

$$T_{(F)} = -49 + \left[(315) \times \left(\frac{T_{HDC3020}}{2^{16} - 1} \right) \right] \quad (3)$$

7.3.4 Drift Correction: Accuracy Restoration

Due to contaminants, the natural aging of the sensor's polymer dielectric, and exposure to extreme operating conditions resulting in long-term drift, the HDC302x offers drift correction to return the device to factory accuracy specification. Drift correction is available on the EVM today with more details in the [HDC3x EVM user's Guide](#) (SNAU267) and documentation for how to use this drift correction feature on individual devices without the EVM will be added to the [HDC3x Silicon User's Guide](#) (SNAU265) before the device releases to production.

7.3.5 NIST Traceability of Relative Humidity and Temperature Sensor

The HDC302x units are 100% tested on a production setup that is NIST traceable and verified with equipment that is calibrated to ISO/IEC 17025 accredited standards. This permits design of the HDC302x into applications such as cold chain management, where the establishment of an unbroken chain of calibrations to known references is essential.

7.3.6 Measurement Modes: Trigger-On Demand vs. Auto Measurement

Two types of measurement modes are available on the HDC302x: Trigger-on Demand and Auto Measurement mode.

Trigger-on Demand is a single measurement reading of temperature and relative humidity that is triggered through an I²C command on an as-needed basis. After the measurement is converted, the device remains in sleep mode until another I²C command is received.

Auto Measurement mode is a recurring measurement reading of temperature and relative humidity, eliminating the need to repeatedly initiate a measurement request through an I²C command. The measurement interval can be adjusted from 1 measurement every 2 seconds to 1 measurement every second. In Auto Measurement mode, the HDC302x wakes up from sleep to measurement mode based on the selected sampling rate.

Auto Measurement mode helps to reduce overall system power consumption in two ways. First, by removing the need to repeatedly initiate a measurement through an I²C command, sink current through the SCL and SDA pullup resistors is eliminated. Secondly, a microcontroller can be programmed into a deep sleep mode, and only woken up through an interrupt by the ALERT pin in the event of excessive temperature and relative humidity measurements.

7.3.7 Heater

The HDC302x includes an integrated heating element that can be switched on to prevent or remove any condensation that may develop when the ambient environment approaches its dew point temperature. Additionally, the heater can be used to verify functionality of the integrated temperature sensor.

If the dew point of an application is continuously calculated and tracked, and the application firmware is written such that it can detect a potential condensing situation (or a period of it), a software subroutine can be run, as a precautionary measure, to activate the onboard heater as an attempt to remove the condensate. The device shall continue to measure and track the %RH level after the heater is activated. Once the %RH reading goes to zero % (or near it), the heater can be subsequently turned off to allow the device to cool down. Cooling of the device can take several minutes, but the temperature measurement will continue to run to ensure the device goes back to normal operating condition before restarting the device for normal service.

Note that when the heater activates, the operating temperature of the device shall be limited based on the *Recommended Operating Conditions* T_{HEATER} limits.

It is important to recognize that the integrated heater evaporates condensate that forms on top of the humidity sensor, but does not remove any dissolved contaminants. Any contaminant residue, if present, may impact the accuracy of the humidity sensor.

7.3.8 ALERT Output With Programmable Interrupts

The ALERT output pin can be used to indicate when the HDC302x records a measurement that indicates either the temperature and/or relative humidity result is outside of a programmed "comfort zone".

The ALERT output pin serves to drive circuit blocks where software monitoring is not feasible. Examples include enabling a power switch to start a dehumidifier, or to initiate a thermal shutdown. Additionally, the ALERT pin can minimize power drain by enabling a microcontroller to remain in deep sleep until environmental conditions require the microcontroller to wake up and perform debug and corrective actions.

7.3.9 Checksum Calculation

Error checking of data is supported with a Checksum Calculation. The 8-bit CRC checksum transmitted after each data word is generated by a CRC algorithm. [Table 7-1](#) shows the CRC properties. The CRC covers the contents of the two previously transmitted data bytes. To calculate the checksum, only these two previously transmitted data bytes are used.

A CRC byte is sent by the HDC302x to the I²C controller in the following cases:

1. Following the transmission of a relative humidity measurement
2. Following the transmission of a temperature measurement
3. Following the transmission of the contents of the [Table 7-12](#)
4. Following the transmission of any of the programmed ALERT limit values (High Alert, Set; High Alert, Clear; Low Alert, Set; Low Alert, Clear)

A CRC byte must be sent by the I²C controller to the HDC302x in the following cases:

1. Following the configuration of any of the ALERT limit values (High Alert, Set; High Alert, Clear; Low Alert, Set; Low Alert, Clear).

Table 7-1. HDC302x CRC Properties

PROPERTY	VALUE
Name	CRC-8
Width	8 bit
Protected Data	Read and/or Write Data
Polynomial	0x31 ($x^8 + x^5 + x^4 + 1$)
Initialization	0xFF
Reflect Input	False
Reflect Output	False
Final XOR	0x00
Examples	CRC of 0xABCD = 0x6F

Retrieving the CRC byte from the HDC302x is optional. A NACK can be issued by the I²C controller prior to reception of the CRC byte to cancel, as shown in [Figure 7-1](#) and [Figure 7-2](#).

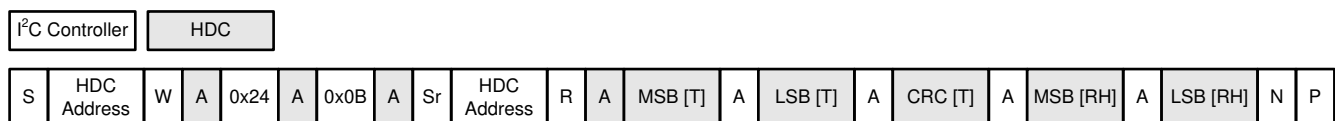

Figure 7-1. Example I²C NACK to Discard CRC Byte Corresponding to Humidity Measurement Readout

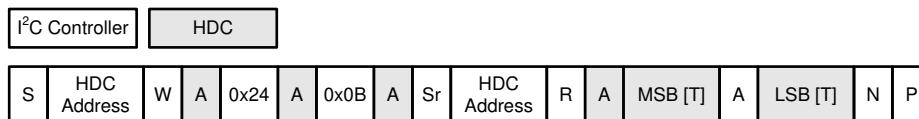

Figure 7-2. Example I²C NACK to Discard CRC Byte Corresponding to Temperature Measurement Readout

7.3.10 Programmable Offset of Relative Humidity and Temperature Results

HDC302x allows for the user to program offset value after the device acquires its relative humidity and temperature results. The offset value can only be used to add or subtract from the sensor measurement results.

7.4 Device Functional Modes

The HDC302x has two modes of operation: Sleep Mode and Measurement Mode.

7.4.1 Sleep Mode vs. Measurement Mode

Sleep mode is the default mode of the HDC302x upon Power Up/Cycle, Hard Reset through the $\overline{\text{RESET}}$ pin, and Soft Reset. The HDC302x will wait for an I²C instruction to trigger a measurement, or to read and write valid data. A measurement request will trigger the HDC302x to switch to measurement mode, where measurements from the integrated sensors are passed through an internal ADC, and go through linearization using calibration data from within the device to produce accurate calculations of temperature and relative humidity. The results are stored in their respective data registers. After completing the conversion, the HDC302x returns to sleep mode.

7.5 Programming

7.5.1 I²C Interface

The HDC302x operates only as a target device on the I²C bus. Multiple devices on the same I²C bus with the same address are not allowed. Connection to the bus is made through the open-drain I/O lines, SCL and SDA. After power-up, the sensor needs at most 3 ms to be ready to begin acquisition of temperature and relative humidity measurements. All data bytes are transmitted MSB first.

7.5.2 I²C Serial Bus Address Configuration

An I²C controller will communicate to a desired target device through a target address byte. The target address byte consists of seven address bits and a direction bit that indicates the intent to execute a read or write operation. The HDC302x features two address pins, which allow for supporting four addressable HDC302x devices on a single I²C bus. [Table 7-2](#) describes the pin logic levels used to communicate up to four devices. HDC302x pins ADDR and ADDR1 must be set before any activity on the interface occurs and remain constant while the device is powered on.

Table 7-2. HDC302x I²C Target Address

ADDR	ADDR1	ADDRESS (Hex Representation)
Logic Low or Open	Logic Low or Open	0x44
Logic Low or Open	Logic High	0x46
Logic High	Logic Low or Open	0x45
Logic High	Logic High	0x47

7.5.3 I²C Write - Send Device Command

Communication to the HDC302x is based upon a command list, which is documented in [Table 7-3](#). Commands other than those documented are undefined and should not be sent to the device. An unsupported command returns a NACK after the pointer, and a read or write operation with incorrect I²C address returns a NACK after the I²C address.

An I²C write sequence is performed to send a command to the HDC302x. Some of these commands also require configuration data from the I²C controller. In those instances, a CRC byte must accompany the

configuration data to permit error checking by the HDC302x. Both of these I²C write scenarios are illustrated in Figure 7-3 and Figure 7-4.

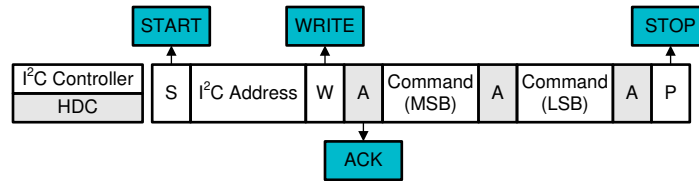

Figure 7-3. I²C Write Command, No Configuration Data Required

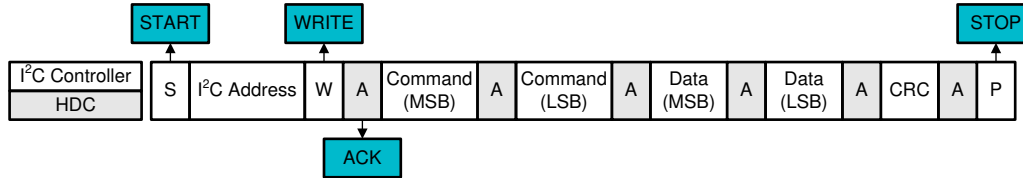

Figure 7-4. I²C Write Command, Configuration Data and CRC Byte Required

7.5.4 I²C Read - Retrieve Single Data Result

An I²C read sequence is performed to retrieve data from the HDC302x. The I²C read sequence *must follow* the I²C write sequence that was used to initiate the data acquisition. A CRC byte always accompanies data that is transmitted by the HDC302x. If the I²C controller does not use the CRC byte to perform a data integrity check, then an I²C NACK can be issued to discard CRC transmission and save time. Both of these I²C read scenarios are illustrated in Figure 7-5 and Figure 7-6.

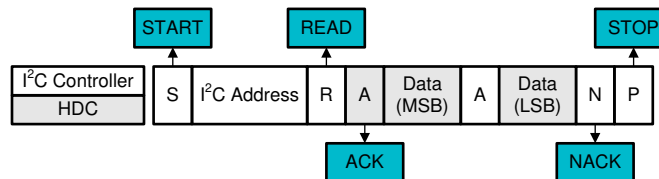

Figure 7-5. I²C Read Single Data Result, CRC Discarded

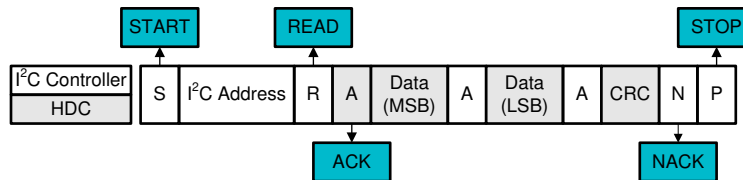

Figure 7-6. I²C Read Single Data Result, CRC Retained

The HDC302x will stop transmission of a data byte if the I²C controller fails to ACK after any byte of data.

7.5.5 I²C Read - Retrieve Multi Data Result

When an I²C read sequence is performed to retrieve multiple data results and the I²C controller does not use the CRC byte to perform a data integrity check, then an I²C NACK can be issued to only discard CRC transmission from the final transmitted data result. Both of these I²C read scenarios are illustrated in Figure 7-7 and Figure 7-8.

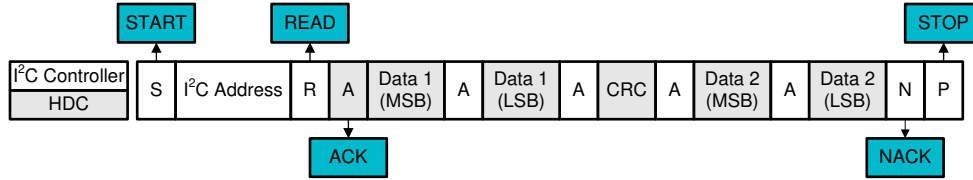

Figure 7-7. I²C Read Multi Data Result, Final CRC Discarded

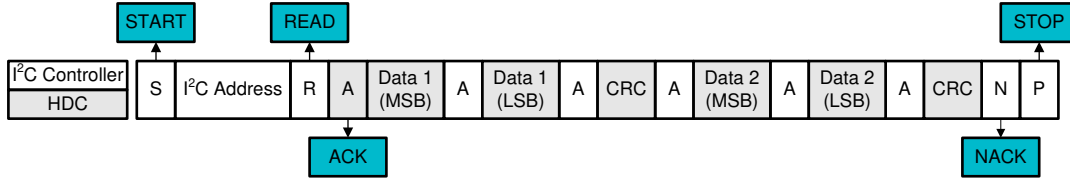

Figure 7-8. I²C Read Multi Data Result, Final CRC Retained

7.5.6 I²C Repeated START - Send Command and Retrieve Data Results

HDC302x supports I²C repeated START, which enables the issue of a command and retrieval of data without releasing the I²C bus. As with all other data retrieval requests, reception of the CRC byte corresponding to the last data result may be discarded or retained. Both of these examples are illustrated in Figure 7-9 and Figure 7-10 for a single data result retrieval, and in Figure 7-11 and Figure 7-12 for a multi data result retrieval.

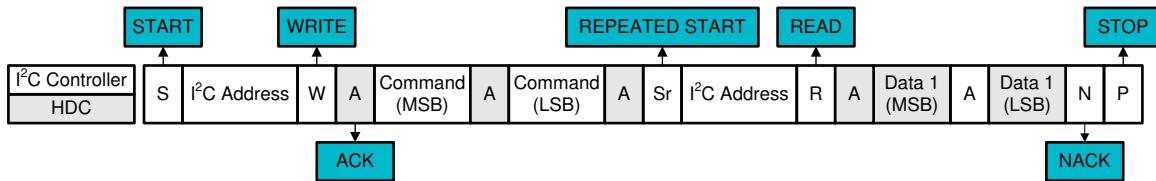

Figure 7-9. I²C Repeated START Sequence, Single Data Result, CRC Discarded

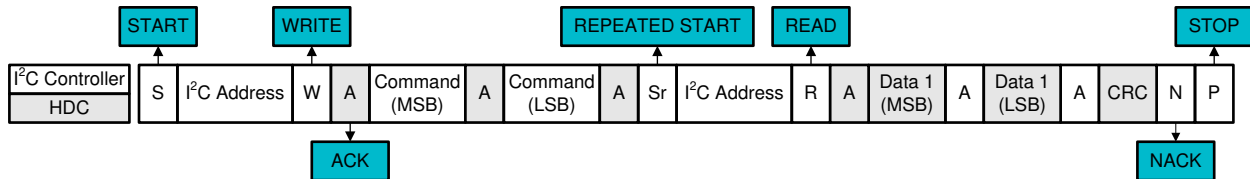

Figure 7-10. I²C Repeated START Sequence, Single Data Result, CRC Retained

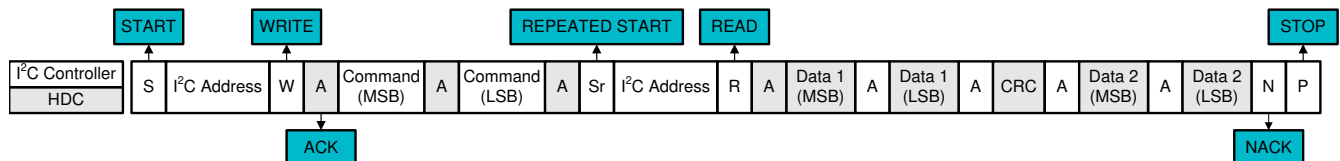

Figure 7-11. I²C Repeated START Sequence, Multi Data Result, Final CRC Discarded

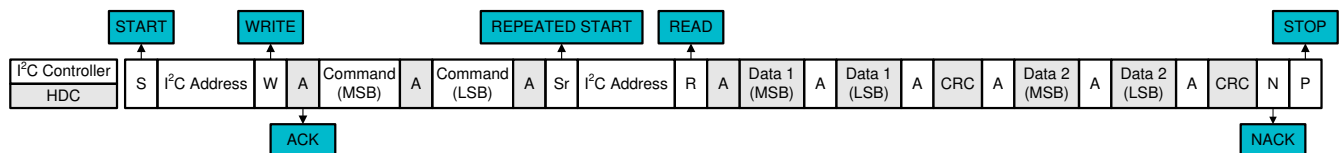

Figure 7-12. I²C Repeated START Sequence, Multi Data Result, Final CRC Retained

ADVANCE INFORMATION

7.5.7 Command Table and Detailed Description

The HDC302x command structure is documented below in [Table 7-3](#). Details about each individual command are documented in the subsections below.

Table 7-3. HDC302x Command Table

HEX CODE (MSB)	HEX CODE (LSB)	COMMAND	COMMAND DETAIL
24	00		Low Power Mode 0 (lowest noise)
24	0B	Trigger-On Demand Mode	Low Power Mode 1
24	16	Single Temperature (T) Measurement	Low Power Mode 2
24	FF	Single Relative Humidity (RH) Measurement	Low Power Mode 3 (lowest power)
20	32		Low Power Mode 0 (lowest noise)
20	24	Auto Measurement Mode	Low Power Mode 1
20	2F	1 measurement per 2 seconds.	Low Power Mode 2
20	FF		Low Power Mode 3 (lowest power)
21	30		Low Power Mode 0 (lowest noise)
21	26	Auto Measurement Mode	Low Power Mode 1
21	2D	1 measurement per second.	Low Power Mode 2
21	FF		Low Power Mode 3 (lowest power)
22	36		Low Power Mode 0 (lowest noise)
22	20	Auto Measurement Mode	Low Power Mode 1
22	2B	2 measurements per second.	Low Power Mode 2
22	FF		Low Power Mode 3 (lowest power)
23	34		Low Power Mode 0 (lowest noise)
23	22	Auto Measurement Mode	Low Power Mode 1
23	29	4 measurements per second.	Low Power Mode 2
23	FF		Low Power Mode 3 (lowest power)
27	37		Low Power Mode 0 (lowest noise)
27	21	Auto Measurement Mode	Low Power Mode 1
27	2A	10 measurements per second.	Low Power Mode 2
27	FF		Low Power Mode 3 (lowest power)
30	93		Exit, then return to Trigger-on Demand Mode.
E0	00		Measurement Readout of T and RH.
E0	02	Auto Measurement Mode	Measurement History Readout of Minimum T.
E0	03		Measurement History Readout of Maximum T.
E0	04		Measurement History Readout of Minimum RH.
E0	05		Measurement History Readout of Maximum RH.
61	00		Programs Thresholds for "Set Low Alert"
61	1D		Programs Thresholds for "Set High Alert"
61	0B	Configure ALERT Thresholds of T and RH	Programs Thresholds for "Clear Low Alert"
61	16		Programs Thresholds for "Clear High Alert"
61	55		Transfer ALERT thresholds into Non-Volatile Memory (NVM)
E1	02		Read Thresholds for "Set Low Alert"
E1	1F	Verify ALERT Thresholds of T and RH	Read Thresholds for "Set High Alert"
E1	09		Read Thresholds for "Clear Low Alert"
E1	14		Read Thresholds for "Clear High Alert"

Table 7-3. HDC302x Command Table (continued)

HEX CODE (MSB)	HEX CODE (LSB)	COMMAND	COMMAND DETAIL
30	6D	Integrated Heater	Enable
30	66		Disable
F3	2D	Status Register	Read Content
30	41		Clear Content
A0	04	Program/Read offset value into/from non-volatile memory	
30	A2	Soft Reset	
36	83	Read NIST ID (Serial Number) Bytes 5 and 4	
36	84	Read NIST ID (Serial Number) Bytes 3 and 2	
36	85	Read NIST ID (Serial Number) Bytes 1 and 0	
37	81	Read Manufacturer ID (Texas Instruments) (0x3000)	
61	BB	Override Default Device Power-On/Reset Measurement State. Table 7-5 lists all valid configuration values that may be sent as part of this command.	

7.5.7.1 Reset

7.5.7.1.1 Soft Reset

The HDC302x provides a software command, as illustrated in [Figure 7-13](#), to force itself into its default state while maintaining supply voltage. It is the software equivalent to a hardware reset through the Power Cycle or toggle of the $\overline{\text{RESET}}$ pin. When executed, the HDC302x will reset its Status Register, reload the calibration data and programmed humidity/temperature offset error from memory, clear previously stored measurement results, set Interrupt Thresholds limits back to their defaults, and re-configure the ALERT output to its default condition.

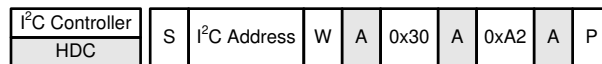

Figure 7-13. I²C Command Sequence: HDC302x Software Reset

7.5.7.1.2 I²C General Call Reset

In addition to the device-specific Soft Reset command, the HDC302x supports the general call address of the I²C specification. This enables the use of a single command to reset an entire I²C system (provided that all devices on the I²C bus support it). [Figure 7-14](#) shows this command. The general call is recognized when the sensor is able to process I²C commands and is functionally equivalent to the Software Reset.

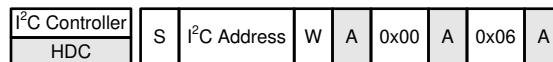

Figure 7-14. I²C Command Sequence: HDC302x Reset Through General Call

7.5.7.2 Trigger-On Demand

This set of commands will trigger a single measurement acquisition of temperature, followed by relative humidity. The HDC302x will transition from sleep mode into measurement mode, and upon measurement completion, return to sleep mode. There are four possible Trigger On Demand commands, each one corresponding to a different low power mode (and therefore, different levels of power consumption). [Table 7-3](#) shows these commands.

The measurement readout from these commands is obtained through an I²C read sequence, as previously documented in [I²C Read - Retrieve Single Data Result](#) and [I²C Read - Retrieve Multi Data Result](#). The format of the measurement readout is two bytes of data representing temperature, followed by one byte CRC checksum, and then another two bytes of data representing relative humidity, followed by one byte CRC checksum as illustrated in [Figure 7-15](#).

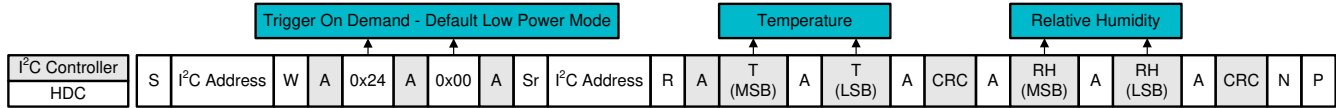

Figure 7-15. I²C Command Sequence: Example Measurement Readout in Trigger-On Demand Mode

If the I²C controller attempts to read the measurements results prior to measurement completion, the HDC302x will respond with a NACK condition, as illustrated in Figure 7-16.

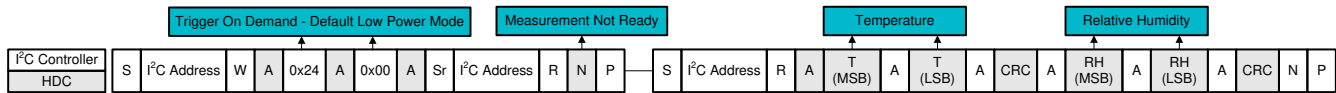

Figure 7-16. I²C Command Sequence: Example Measurement Not Ready in Trigger-On Demand Mode

7.5.7.3 Auto Measurement Mode

Auto Measurement mode forces the HDC302x to perform a temperature and relative humidity measurement at a specific timing interval, removing the need for the I²C controller to repeatedly initiate a measurement acquisition. This section gives additional details for each command

7.5.7.3.1 Auto Measurement Mode: Enable and Configure Measurement Interval

There are 20 possible timing intervals when Auto Measurement mode is enabled, (and therefore, different levels of average power consumption). These commands are documented in Table 7-3. To avoid self-heating of the temperature sensor, TI recommends to limit the sampling interval to no faster than 1 measurement/second, as illustrated in Figure 7-17.

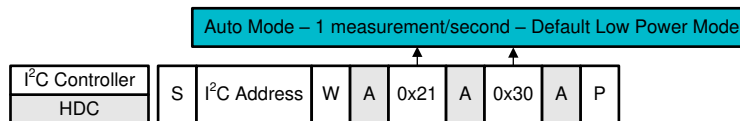

Figure 7-17. I²C Command Sequence: Enable Auto Measurement mode at 1 Measurement per Second

7.5.7.3.2 Auto Measurement Mode: Measurement Readout

The latest measurement acquisition in Auto Measurement Mode can be retrieved using a measurement readout command, which is documented in Table 7-3, and illustrated in Figure 7-18. Once the measurement readout is complete, the HDC302x clears the measurement result from memory.

As in *Trigger-On Demand*, if the I²C controller attempts to read the measurement results prior to measurement completion, the HDC302x will respond with a NACK condition.

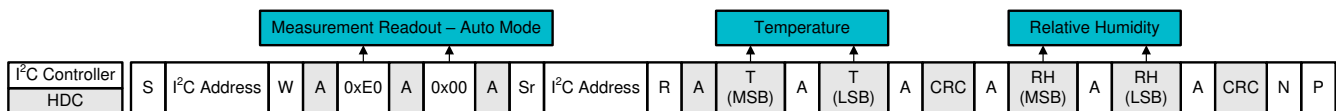

Figure 7-18. I²C Command Sequence: Measurement Readout in Auto Measurement Mode

7.5.7.3.3 Auto Measurement Mode: Exit

The command to exit Auto Measurement mode is documented in Table 7-3 and illustrated in Figure 7-19. The HDC302x will immediately discontinue any measurement in progress and return to sleep mode. This takes typically 1 ms.

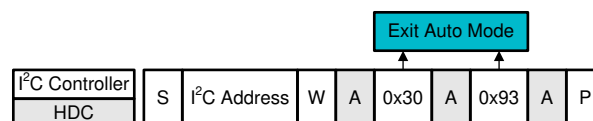

Figure 7-19. I²C Command Sequence: Exit Auto Measurement Mode

7.5.7.3.4 Auto Measurement Mode: Measurement History Readout

Within Auto Measurement Mode, the HDC302x maintains a history of the maximum and minimum measurement for temperature and relative humidity (described as variables MIN T, MAX T, MIN RH, and MAX RH). This feature is useful for scenarios where the user would like to assess if the ambient conditions ever approached, but did not surpass, the defined environmental thresholds as documented in [Section 7.5.7.4.1](#). [Table 7-4](#) summarizes the status of MIN T, MAX T, MIN RH, and MAX RH based on device configuration.

Table 7-4. Status of Measurement History Variables based on HDC302x Configuration

HDC302x Configuration	MIN T	MAX T	MIN RH	MAX RH
Outside of Auto Measurement Mode	130°C	-45°C	100%	0%
Within Auto Measurement Mode	Monitored and Latched When Appropriate			

Whenever the HDC302x exits Auto Measurement Mode (e.g. via Auto Measurement Mode: Exit, Soft Reset, General Call Reset, or), all four variables will return to their default values documented in [Table 7-4](#). Therefore, measurement history readouts outside of Auto Measurement Mode are invalid. [Figure 7-20](#), [Figure 7-21](#), [Figure 7-22](#), and [Figure 7-23](#) illustrate the I²C sequence for measurement readout of MIN T, MAX T, MIN RH, and MAX RH.

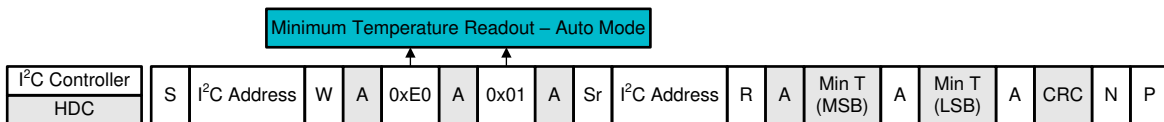

Figure 7-20. I²C Sequence: Minimum Temperature Measurement Readout (Auto Measurement Mode)

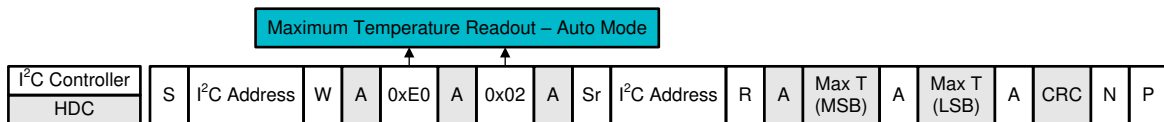

Figure 7-21. I²C Sequence: Maximum Temperature Measurement Readout (Auto Measurement Mode)

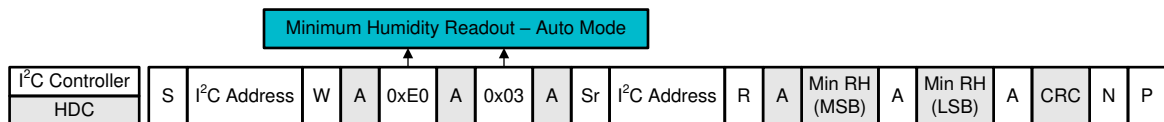

Figure 7-22. I²C Sequence: Minimum Relative Humidity Measurement Readout (Auto Measurement Mode)

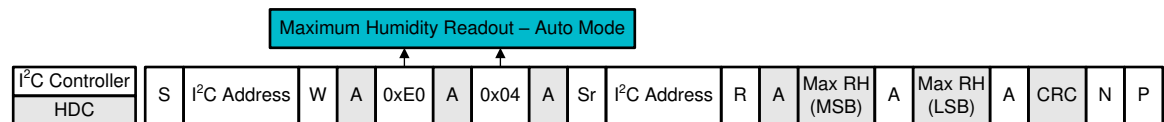

Figure 7-23. I²C Sequence: Maximum Relative Humidity Measurement Readout (Auto Measurement Mode)

7.5.7.3.5 Override Default Device Power-On and Device-Reset State

The HDC302x defaults to entering sleep mode after a device power-on or a device-reset. However, an override command may be sent to the HDC302x to force entry into Automatic Measurement mode upon every device power-on and device-reset. The command is illustrated in below in [Figure 7-24](#) and the list of all possible command configurations is documented in [Table 7-5](#).

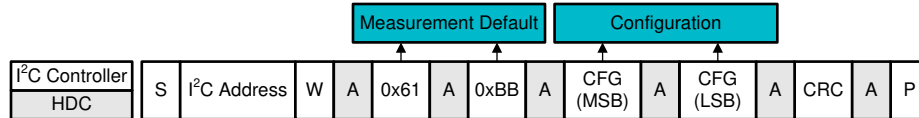

Figure 7-24. I²C Sequence: Configure Default Measurement

Table 7-5 lists all valid configuration values that may be sent as part of this command.

Table 7-5. List of Valid Measurement Configuration Values to send to HDC302x

CFG (MSB)	CFG (LSB)	CRC	Configuration	Low Power Mode	Measurements per Second
0x00	0x03	0xB0	Automatic Measurement Mode	0 (lowest noise)	0.5
	0x05	0xD2	Automatic Measurement Mode	0 (lowest noise)	1
	0x07	0x74	Automatic Measurement Mode	0 (lowest noise)	2
	0x09	0x16	Automatic Measurement Mode	0 (lowest noise)	4
	0x0B	0x09	Automatic Measurement Mode	0 (lowest noise)	10
	0x13	0xF3	Automatic Measurement Mode	1	0.5
	0x15	0x91	Automatic Measurement Mode	1	1
	0x17	0x37	Automatic Measurement Mode	1	2
	0x19	0x55	Automatic Measurement Mode	1	4
	0x1B	0x4A	Automatic Measurement Mode	1	10
	0x23	0x36	Automatic Measurement Mode	2	0.5
	0x25	0x54	Automatic Measurement Mode	2	1
	0x27	0xF2	Automatic Measurement Mode	2	2
	0x29	0x90	Automatic Measurement Mode	2	4
	0x2B	0x8F	Automatic Measurement Mode	2	10
	0x33	0x75	Automatic Measurement Mode	3 (lowest power)	0.5
	0x35	0x17	Automatic Measurement Mode	3 (lowest power)	1
	0x37	0xB1	Automatic Measurement Mode	3 (lowest power)	2
	0x39	0xD3	Automatic Measurement Mode	3 (lowest power)	4
	0x3B	0xCC	Automatic Measurement Mode	3 (lowest power)	10
0x00	0x81		Restores Factory Default (Sleep Mode)	N/A	N/A

7.5.7.4 ALERT Output Configuration

The HDC302x provides hardware notification of events through an interrupt output pin (ALERT). Specifically, the ALERT output represents the status of bits 15, 11, 10, and 4 from the Status Register [Section 7.5.7.6](#). The ALERT output asserts to Logic High upon detection of an event and de-asserts to Logic Low when the event has passed or after the Status Register [Section 7.5.7.6](#) is cleared.

The ALERT output is activated by default upon Power Up, Hardware Reset, and Soft Reset. It is deactivated when the HDC302x has been disabled via assertion of the $\overline{\text{RESET}}$ pin. When deactivated, the HDC302x will clear the Status Register [Section 7.5.7.6](#).

If temperature and relative humidity tracking through the ALERT output is not desired, the feature can be disabled as explained in [Section 7.5.7.4.4](#)

7.5.7.4.1 ALERT Output: Environmental Tracking of Temperature and Relative Humidity

The primary use of the ALERT output is to provide a hardware notification of ambient temperature and relative humidity measurements that violate programmed thresholds. There are a total of four programmable thresholds for temperature and relative humidity, as documented in [Table 7-3](#) and illustrated in [Figure 7-25](#) below.

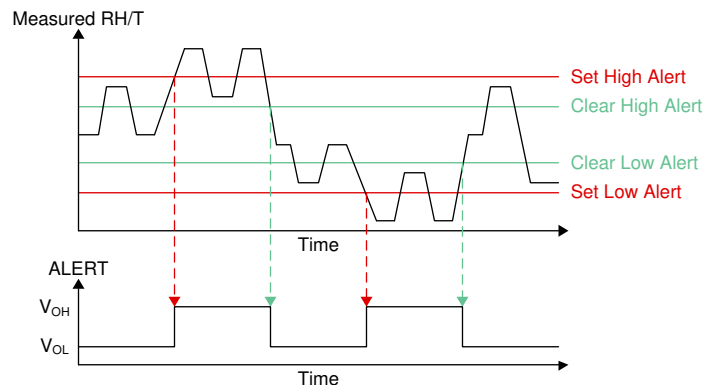

Figure 7-25. Graphical Illustration of ALERT Programmable Environmental Thresholds

The four programmable thresholds are listed below

1. **Set High Alert:** Asserts ALERT output when HDC302x measures a temperature or relative humidity level that has risen above this value.
2. **Clear High Alert:** Deasserts the ALERT output caused by [Set High Alert](#), once HDC302x measures a temperature or relative humidity level that has fallen below this value.
3. **Set Low Alert:** Programmed value that asserts ALERT output when HDC302x measures a temperature or relative humidity level that has fallen below this value.
4. **Clear Low Alert:** Programmed value that deasserts the ALERT output caused by [Set Low Alert](#), once HDC302x measures a temperature of relative humidity level that has risen above this value.

If the user application utilizes the ALERT output for environmental tracking, it is best practice to program these four thresholds prior to any temperature or relative humidity measurement acquisition. Programming enough separation between the Set versus Clear thresholds will prevent fast oscillations of the ALERT output.

These programmed limits are accessible at any time of operation .

7.5.7.4.2 ALERT Output: Representation of Environmental Thresholds and Default Threshold Values

The [Set High Alert](#), [Clear High Alert](#), [Set Low Alert](#), and [Clear Low Alert](#) thresholds are each represented by a truncated 16 bit value, as illustrated [Figure 7-26](#). The 7 MSBs from a relative humidity measurement are concatenated with the 9 MSBs from a temperature measurement. The actual temperature and relative humidity measurement result are always stored as a 16-bit value, but when compared against the programmed threshold values, due to the truncated representation, there is a resolution loss of 0.5°C in temperature and a 1% resolution loss in relative humidity.

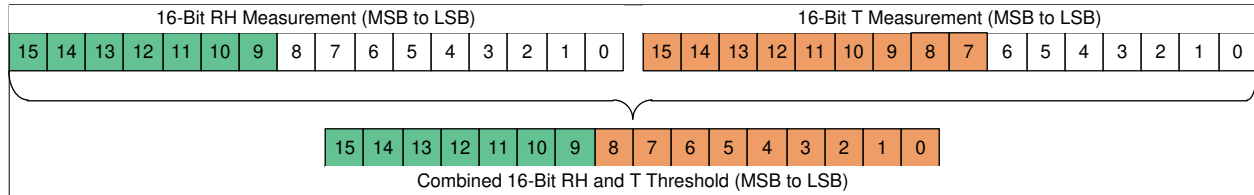

Figure 7-26. Representation of ALERT Threshold Value Using Combined RH and T

The default values of the relative humidity and temperature thresholds after Power Up/Cycle, Hardware Reset, and Soft Reset are documented in [Table 7-6](#) below. Refer to [Table 7-3](#) for the appropriate command to re-program the thresholds.

Table 7-6. Default Value of ALERT Thresholds

ALERT THRESHOLD	DEFAULT RH THRESHOLD	DEFAULT T THRESHOLD	HEX VALUE	CRC
Set High Alert	80% RH	60°C	0xCD33	0xFD
Clear High Alert	79% RH	58°C	0xC92D	0x22
Set Low Alert	20% RH	-10°C	0x3466	0xAD
Clear Low Alert	22% RH	-9°C	0x3869	0x37

7.5.7.4.3 ALERT Output: Steps to Calculate and Program Environmental Thresholds

The steps to calculate the [Set High Alert](#), [Clear High Alert](#), [Set Low Alert](#), and [Clear Low Alert](#) thresholds are listed below:

1. Select the desired relative humidity and temperature threshold to program, and the programmed value.
2. Convert the relative humidity and temperature threshold value to its respective 16-bit binary value
3. Retain the 7 MSBs for relative humidity and the 9 MSBs for temperature
4. Concatenate the 7 MSBs for relative humidity with the 9 MSBs for temperature to complete the 16-bit threshold representation
5. Calculate the CRC byte from the 16-bit threshold value

An example is provided below.

1. In this case, the [Set High Alert](#) threshold will be programmed to 90% RH and 65°C
2. 90% RH converts to 0b1110011001100111 and 65°C T converts to 0b1010000011101011
3. 7 MSBs for 90% RH is 0b1110011 and 9 MSBs for 65°C T is 0b101000001
4. After concatenation of the relative humidity and temperature MSBs, the threshold representation is 0b111001101000001 = 0xE741
5. For 0xE741, this corresponds to a CRC byte 0x55
 - a. [Figure 7-27](#) illustrates the appropriate command to send to the HDC302x.
 - b. The HDC302x will respond to reception of an incorrect CRC byte with a I²C NACK.

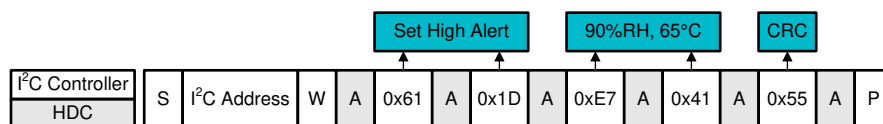

Figure 7-27. I²C Command Sequence: Example Programming of Set High Alert to 90% RH, 65°C

7.5.7.4.4 ALERT Output: Deactivation of Environmental Tracking

To deactivate the ALERT output from responding to measurement results of temperature and/or relative humidity, the **Set High Alert** thresholds must be programmed to be lower than the **Set Low Alert** thresholds. **Figure 7-28** illustrates an example of threshold programming that disables tracking of temperature as well as relative humidity. To be more specific:

- To disable Temperature Alert Tracking: Configure the temperature bits within the **Set Low Alert** threshold to be larger than the temperature bits within the **Set High Alert** threshold.
- To disable Humidity Alert Tracking: Configure the humidity bits within the **Set Low Alert** threshold to be larger than the humidity bits within the **Set High Alert** threshold.

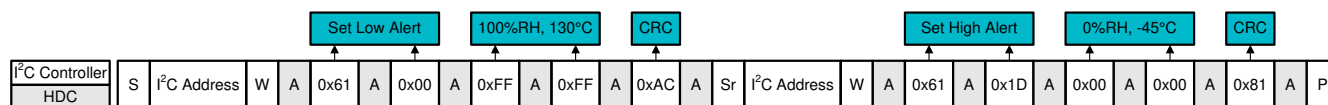

Figure 7-28. I²C Command Sequence: Example to Deactivate ALERT Output Tracking of Temperature and Relative Humidity

7.5.7.4.5 ALERT Output: Transfer Thresholds into Non-Volatile Memory

This command, illustrated below in **Figure 7-29**, enables an override of the default ALERT threshold values after a device reset or power cycle. This permits independent assembly of a sensor board and a remote MCU board. Normally, the MCU is local to the sensor (that is, they share a common board) and the MCU will program the threshold values. However, there are applications where the sensor and MCU are on separate boards, and deployed to various applications, each with unique threshold requirements. This normally adds significant tracking overhead (that is, each MCU board must be assigned to a specific sensor board). With this feature, the HDC302x thresholds may be configured using a debugger/programmer during product assembly, and later on, connected to any MCU board on its own assembly, with the application-specific thresholds already ensured.

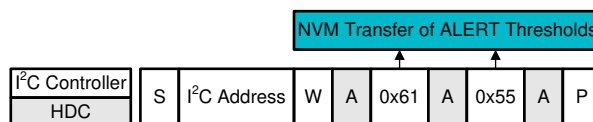

Figure 7-29. I²C Command Sequence: Transfer ALERT Thresholds into NVM

7.5.7.5 Programmable Measurement Offset

The HDC302x can be programmed to return a relative humidity measurement and/or a temperature measurement that accounts for a programmed offset value. An operation bit determines whether to add or subtract the offset from the actual sensor measurement results. This feature is targeted for designs where local heat sources can not be isolated from the temperature sensor and said heat sources show variation over time (due to different components being enabled/disabled). The command is documented in the [Table 7-3](#). The device should be in shutdown mode when changing the offset because if it is in [Auto Measurement mode](#), it could give unpredictable results.

Programming either offset value requires programming of a corresponding non-volatile memory location in the EEPROM. Therefore, I²C writes are not permitted until offset programming is complete. Refer to the **electrical characteristics table** t_{OS_PROG} parameters for the time to complete a programming a single location. The HDC302x will draw approximately 230 μ A during offset programming.

7.5.7.5.1 Representation of Offset Value and Factory Shipped Default Value

As illustrated in [Figure 7-30](#), the programmed offset values for relative humidity (RH_{OS}) and temperature (T_{OS}) are combined into a single 16-bit representation. 7 bits represent RH_{OS} , 7 bits represent T_{OS} , 1 operation bit ($RH_{+/-}$) to add or subtract RH_{OS} , and 1 operation bit ($T_{+/-}$) to add or subtract T_{OS} . From the 16-bit representation of relative humidity, bits 13 through 7 are used to represent RH_{OS} . From the 16-bit representation of temperature, bits 12 through 6 are used to represent T_{OS} .

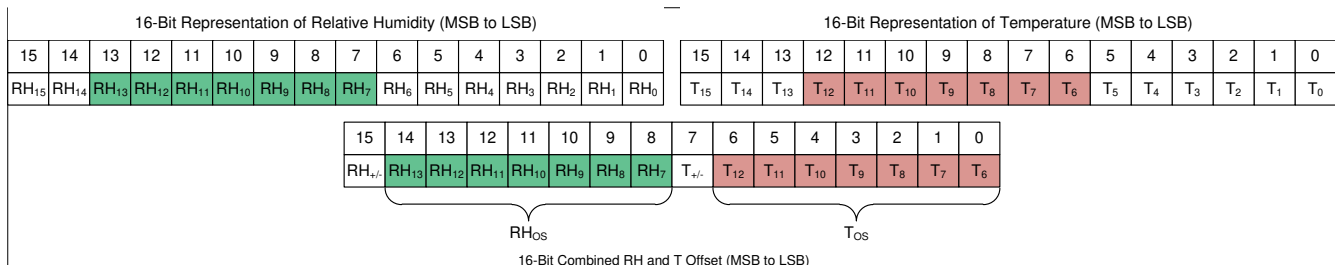

Figure 7-30. Data Structure to Represent Programmed Offset Values for RH and T

7.5.7.5.2 Factory Shipped Default Offset Values

The HDC302x is factory-shipped with default values of RH_{OS} and T_{OS} as documented in [Table 7-7](#).

Table 7-7. Factory Shipped Default Offset Value

DEFAULT RH_{OS} [%]	DEFAULT T_{OS} [°C]	HEX VALUE (0x)	CRC (0x)
0	0	00 00	81

7.5.7.5.3 Calculate Relative Humidity Offset Value

[Table 7-8](#) documents the programmed offset value that is represented by each individual relative humidity offset bit within RH_{OS} . The minimum programmable offset is 0.1953125% and the maximum programmable offset is 24.8046875%.

Table 7-8. Relative Humidity Offset Value (RH_{OS}) Represented by Each Data Bit

RH OFFSET BIT	VALUE WHEN PROGRAMMED TO 0	VALUE WHEN PROGRAMMED TO 1
$RH_{+/-}$	Subtract	Add
RH_{13}	0	12.5
RH_{12}	0	6.25
RH_{11}	0	3.125
RH_{10}	0	1.5625
RH_9	0	0.78125
RH_8	0	0.390625

Table 7-8. Relative Humidity Offset Value (RH_{OS}) Represented by Each Data Bit (continued)

RH OFFSET BIT	VALUE WHEN PROGRAMMED TO 0	VALUE WHEN PROGRAMMED TO 1
RH ₇	0	0.1953125

Table 7-9 below gives an example of some of the possible calculated relative humidity offset values (including the operation bit RH_{+/-}):

Table 7-9. Example Programmed Values of RH_{OS}

RH _{+/-}	RH ₁₃	RH ₁₂	RH ₁₁	RH ₁₀	RH ₉	RH ₈	RH ₇	RH OFFSET VALUE
1	0	0	0	0	0	0	1	+0.1952125% RH
0	0	0	0	0	0	0	1	-0.1952125% RH
1	1	0	0	0	0	0	0	+12.5% RH
0	1	0	0	0	0	0	0	-12.5% RH
1	0	1	0	1	0	1	0	+8.203125% RH
0	0	1	0	1	0	1	0	-8.203125% RH
1	1	1	1	1	1	1	1	+24.8046875% RH
0	1	1	1	1	1	1	1	-24.8046875% RH

7.5.7.5.4 Calculate Temperature Offset Value

Table 7-10 documents the programmed offset value that is represented by each individual relative temperature offset bit within T_{OS}. The minimum programmable offset is 0.1708984375°C and the maximum programmable offset is 21.7041015625°C.

Table 7-10. Temperature Offset Value (T_{OS}) Represented by Each Data Bit

T OFFSET BIT	VALUE WHEN PROGRAMMED TO 0	VALUE WHEN PROGRAMMED TO 1
T _{+/-}	Subtract	Add
T ₁₂	0	10.9375
T ₁₁	0	5.46875
T ₁₀	0	2.734375
T ₉	0	1.3671875
T ₈	0	0.68359375
T ₇	0	0.341796875
T ₆	0	0.1708984375

Table 7-11 below gives an example of some of the possible calculated temperature offset values (including the operation bit T_{+/-}):

Table 7-11. Example Programmed Values of T_{OS}

T _{+/-}	T ₁₂	T ₁₁	T ₁₀	T ₉	T ₈	T ₇	T ₆	T OFFSET VALUE
1	0	0	0	0	0	0	1	+0.1708984375°C
0	0	0	0	0	0	0	1	-0.1708984375°C
1	1	0	0	0	0	0	0	+10.9375°C
0	1	0	0	0	0	0	0	-10.9375°C
1	0	1	0	1	0	1	0	+7.177734375°C
0	0	1	0	1	0	1	0	-7.177734375°C
1	1	1	1	1	1	1	1	21.7041015625°C
0	1	1	1	1	1	1	1	-21.7041015625°C

7.5.7.5.5 Write an Offset Value

After determining the desired value of $RH_{+/-}$, RH_{OS} , $T_{+/-}$, and T_{OS} , as documented in [Calculate Relative Humidity Offset Value](#) and [Calculate Temperature Offset Value](#), determine the correct CRC checksum and send all three bytes to the HDC302x as illustrated in [Figure 7-31](#) (along with an example scenario of +8.20% RH and $-7.17^{\circ}C$).

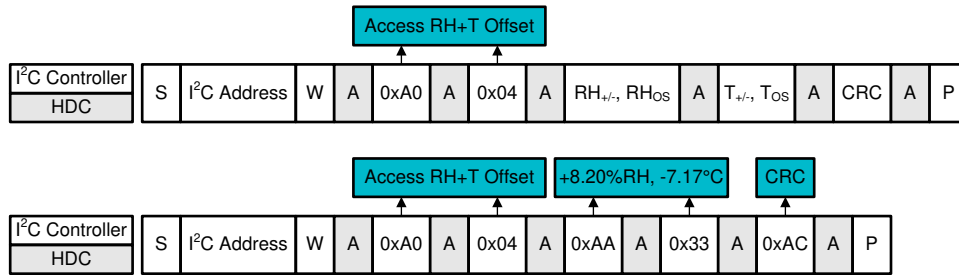

Figure 7-31. I²C Command Sequence: RH and T Offset (Example With +8.20% RH and $-7.17^{\circ}C$)

7.5.7.5.6 Verify a Programmed Offset Value

The command to verify the programmed offset values is documented in [Table 7-3](#) and the command sequence is illustrated in [Figure 7-32](#).

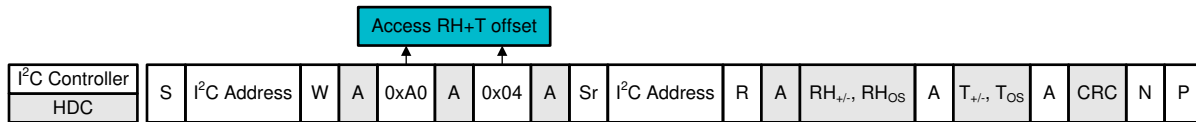

Figure 7-32. I²C Command Sequence: Verify Programmed RH and T Offset

7.5.7.6 Status Register

The Status Register contains real-time information about the operating state of the HDC302x, as documented in [Table 7-12](#). There are two commands associated with the Status Register: Read Content and Clear Content, as documented in [Table 7-3](#) and illustrated in [Figure 7-33](#) and [Figure 7-34](#).

Table 7-12. Customer View: Status Register

BIT	DEFAULT	DESCRIPTION
15	1	Overall Alert Status 0 = No active alerts 1 = At least one active alert
14	0	Reserved
13	0	Heater Status 0 = Heater Disabled 1 = Heater Enabled
12	0	Reserved
11	0	RH Tracking Alert 0 = No RH alert 1 = RH alert
10	0	T Tracking Alert 0 = No T alert 1 = T alert
9	0	RH High Tracking Alert 0 = No RH High alert 1 = RH High alert
8	0	RH Low Tracking Alert 0 = No RH Low alert 1 = RH Low alert
7	0	T High Tracking Alert 0 = No T High alert 1 = T High alert
6	0	T Low Tracking Alert 0 = No T Low alert 1 = T Low alert
5	0	Reserved
4	1	Device Reset Detected 0 = No reset detected since last clearing of Status Register 1 = Device reset detected (via hard reset, soft reset command or supply fail)
3	0	Reserved
2	0	Reserved
1	0	Reserved
0	0	Checksum verification of last data write 0 = Pass (correct checksum received) 1 = Fail (incorrect checksum received)

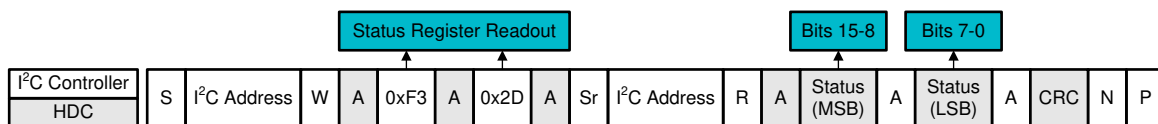

Figure 7-33. I²C Command Sequence: Read Status Register



Figure 7-34. I²C Command Sequence: Clear Status Register

7.5.7.7 Heater: Enable and Disable

The HDC302x includes an integrated heater with enough current draw (up to 45 mA) to enable operation in condensing environments. The heater protects the humidity sensor area by preventing condensation as well as removing condensate. Enabling and disabling of the heater is documented in [Table 7-3](#) and illustrated in [Figure 7-35](#) and [Figure 7-36](#).

The heater is expected to impact the temperature measurement result and the relative humidity measurement result. An IC-based humidity sensor uses the die temperature as an estimate for the ambient temperature. Use of the heater will increase the die temperature up to 60°C above ambient temperature. Therefore, accurate measurement results of ambient temperature and relative humidity are not possible when the heater is in operation.

As long as condensate is present on the RH sensor, the measurement reading will continue to be > 99%. Continue enabling the heater until the RH measurement reading falls to below 80%. In most cases, 2-3 minutes of heater enable time is sufficient. It is best practice to ensure that the ambient temperature is higher than the dew point temperature.

It is important to recognize that the integrated heater will evaporate condensate that forms on top of the humidity sensor, but does not remove any dissolved contaminants. This contaminant residue, if present, may impact the accuracy of the humidity sensor.

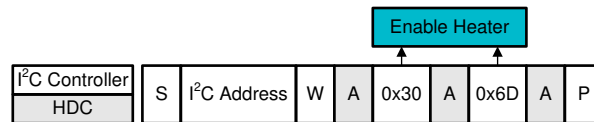

Figure 7-35. I²C Command Sequence: Enable Heater

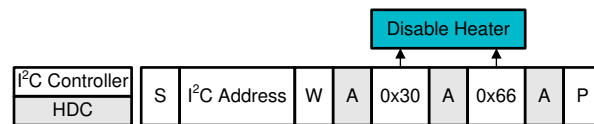

Figure 7-36. I²C Command Sequence: Disable Heater

7.5.7.8 Read NIST ID/Serial Number

Each HDC302x is configured with a unique 48-bit value that is used to support NIST traceability of the temperature and relative humidity sensor. It can also be used to represent the unique serial number for that device. Three commands are required to read the full 48-bit value as illustrated in [Figure 7-37](#), [Figure 7-38](#), and [Figure 7-39](#). Each command will return two bytes of NIST ID followed by a CRC byte. From MSB to LSB, the full device NIST ID is read as NIST_ID_5, NIST_ID_4, NIST_ID_3, NIST_ID_2, NIST_ID_1, and NIST_ID_0.

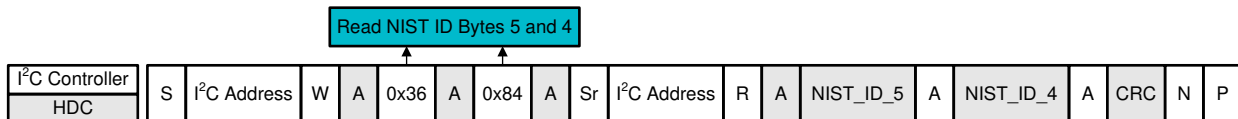

Figure 7-37. I²C Command Sequence: Read NIST ID (Bytes NIST_ID_5, Then NIST_ID_4)

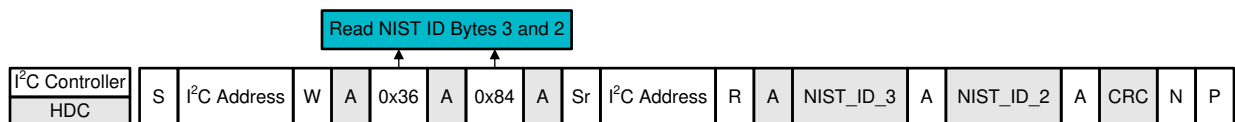

Figure 7-38. I²C Command Sequence: Read NIST ID (Bytes NIST_ID_3, Then NIST_ID_2)

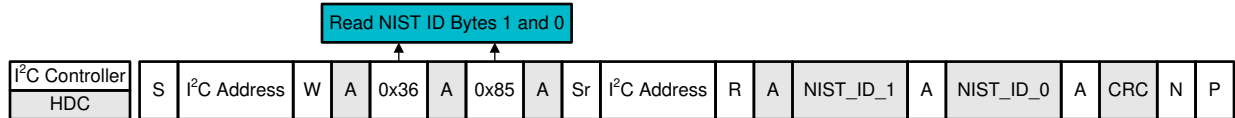

Figure 7-39. I²C Command Sequence: Read NIST ID (Bytes NIST_ID_1, Then NIST_ID_0)

8 Application and Implementation

Note

Information in the following applications sections is not part of the TI component specification, and TI does not warrant its accuracy or completeness. TI's customers are responsible for determining suitability of components for their purposes, as well as validating and testing their design implementation to confirm system functionality.

8.1 Application Information

The HDC302x is used to measure the relative humidity and temperature of the board location where the device is mounted. The programmable I²C address option allow up to four locations be monitored on a single serial bus.

8.2 Typical Application

One common application which requires a relative humidity and temperature sensor is a HVAC system thermostat control. It is based on environmental sensors and a microcontroller. The microcontroller acquires data from humidity and temperature sensors and controls the heating and cooling system. The collected data are then shown on a display that can be easily controlled by the microcontroller. Based on data from the humidity and temperature sensor, the heating and cooling system then maintains the environment at the customer-defined preferred conditions.

In a battery-powered HVAC system thermostat, one of the key parameters in the selection of components is the power consumption. The HDC302x, with 550 nA of current consumption (the average consumption over 1 s for RH and Temperature measurements), in conjunction with a MSP430, represents one way an engineer can obtain low power consumption and extend battery life. A system block diagram of a battery-powered thermostat is shown in [Figure 8-1](#).

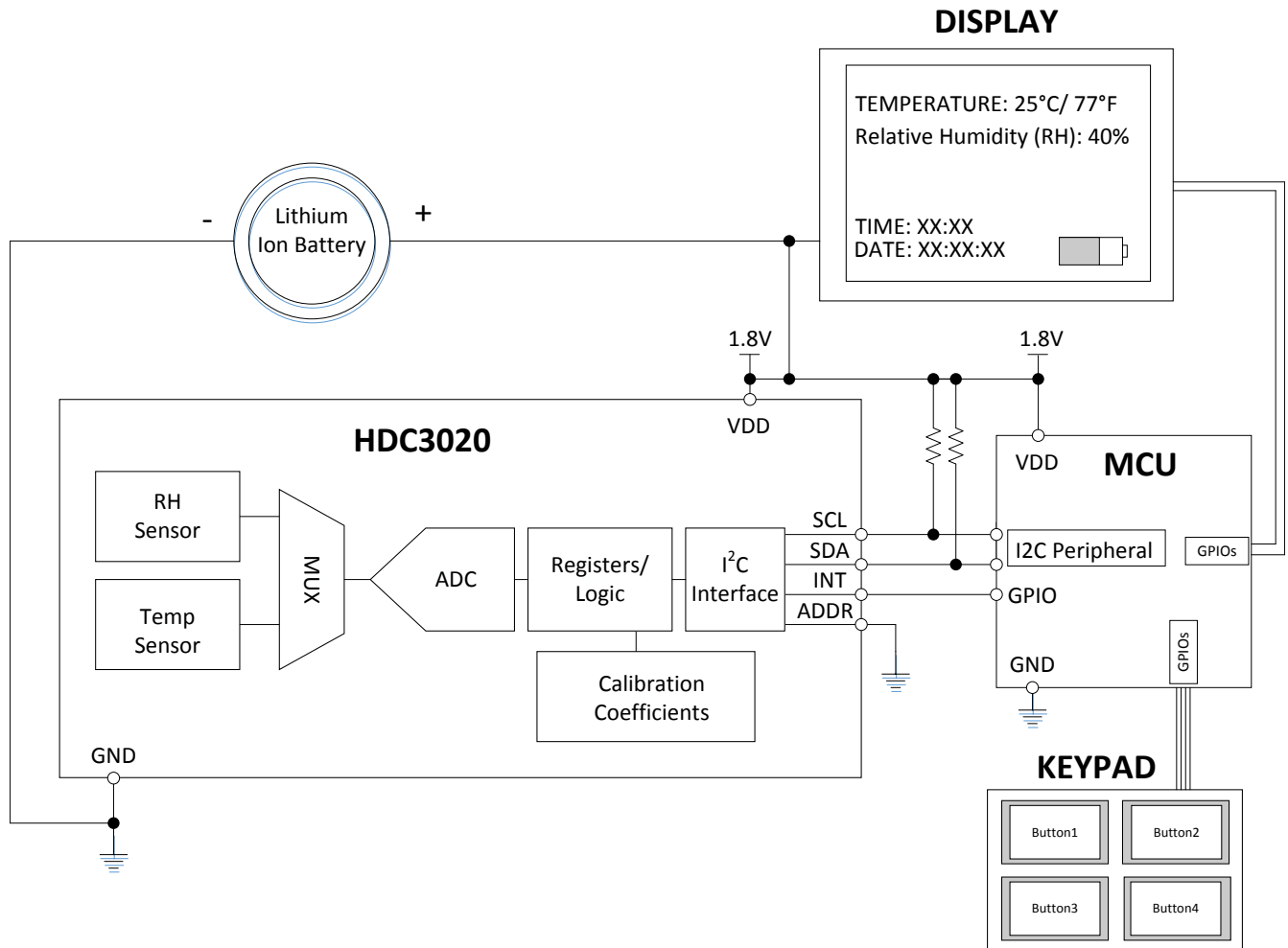

Figure 8-1. Typical Application Schematic HVAC

8.2.1 Design Requirements

To improve measurement accuracy, TI recommends to isolate the HDC302x from all heat sources in the form of active circuitry, batteries, displays and resistive elements. If design space is a constraint, cutouts surrounding the device or the inclusion of small trenches can help minimize heat transfer from PCB heat sources to the HDC302x. To avoid self-heating the HDC302x, TI recommends to configure the device to no faster than 1 measurement/second.

The HDC302x operates only as a target device and communicates with the host through the I2C-compatible serial interface. SCL is an input pin, SDA is a bidirectional pin, and ALERT is an output. The HDC302x requires a pullup resistor on the SDA. An SCL pullup resistor is required if the system microprocessor SCL pin is open-drain. The recommended value for the pullup resistors is 5 k Ω . In some applications, the pullup resistor can be lower or higher than 5 k Ω . A 0.1- μ F bypass capacitor is recommended to be connected between V+ and GND. Use a ceramic capacitor type with a temperature rating that matches the operating range of the application, and place the capacitor as close as possible to the VDD pin of the HDC302x. The ADDR and ADDR0 pins should be connected directly to GND, VDD, or left open for address selection of four possible unique target ID addresses per the addressing scheme [Table 7-2](#). The ALERT output pin can be connected to a microcontroller interrupt that triggers an event that occurred when the relative humidity and/or temperature limit exceeds the programmed value. The ALERT pin should be left floating when not in use.

8.2.2 Detailed Design Procedure

When a circuit board layout is created from the schematic shown in [Figure 8-1](#), a small circuit board is possible. The accuracy of a temperature and relative humidity measurement is dependent upon the sensor accuracy

and the setup of the sensing system. Since the HDC302x measures relative humidity and temperature in its immediate environment, it is critical that the local conditions at the sensor match the ambient environment. Use one or more openings in the physical cover of the thermostat to obtain a good airflow even in static conditions. Refer to the layout (Figure 10-1) for a PCB layout which minimizes the thermal mass of the PCB in the region of the HDC302x, which can improve measurement response time and accuracy.

8.2.3 Application Curve

These results were acquired at $T_A = 25^\circ\text{C}$ using a humidity chamber that sweeps RH%. The sweep profile used was 10% > 20% > 30% > 40% > 50% > 60% > 70% > 80% > 70% > 60% > 50% > 40% > 30% > 20% > 10%. Each RH% set point was held for 20 minutes.



Figure 8-2. RH% Readings of Chamber and HDC302x vs. Time

9 Power Supply Recommendations

The HDC302x supports a voltage supply range from 1.62 V up to 5.50 V. TI recommends a multilayer ceramic bypass X7R capacitor of 0.1 μ F between the V_{DD} and GND pins.

10 Layout

10.1 Layout Guidelines

Proper PCB layout of the HDC302x is critical to obtaining accurate measurements of temperature and relative humidity. Therefore, TI recommends to:

1. Isolate all heat sources from the HDC302x. This means positioning the HDC302x away from power intensive board components such as a battery, display, or microcontroller. As illustrated in [Figure 10-1](#), ideally the only onboard component close to the HDC302x is the supply bypass capacitor.
2. Eliminate copper layers below the device (GND, V_{DD})
3. Use slots or a cutout around the device to reduce the thermal mass and obtain a quicker response time to sudden environmental changes.
 - The diameter of the cutout around the part in this case is approximately 6 mm. The important details are to implement a separation of thermal planes while allowing for power, ground and data lines and place the part on the board, while still meeting mechanical assembly requirements. In addition [Figure 10-1](#) other representations of cutouts for thermal relief can be found in [SNAA297](#) section 2.3.
4. Follow the Example Board Layout and Example Stencil Design that is illustrated in [Mechanical, Packaging, and Orderable Information](#).
 - The SCL and the SDA lines require pull up resistors and TI recommends to connect a 0.1-uF cap to the VDD line.
 - TI recommends a multilayer ceramic bypass X7R capacitor of 0.1 μ F between the VDD and GND pins.
5. It is generally best practice to solder the package thermal pad to a board pad that is connected to ground, however to minimize thermal mass for maximum heater efficiency or to measure ambient temperature it may be left floating. Floating the thermal pad is an option because the thermal pad has a non-conductive epoxy. See HDC3x Silicon User guide for more information regarding when leaving the thermal pad floating may be helpful. for your application

10.2 Layout Example

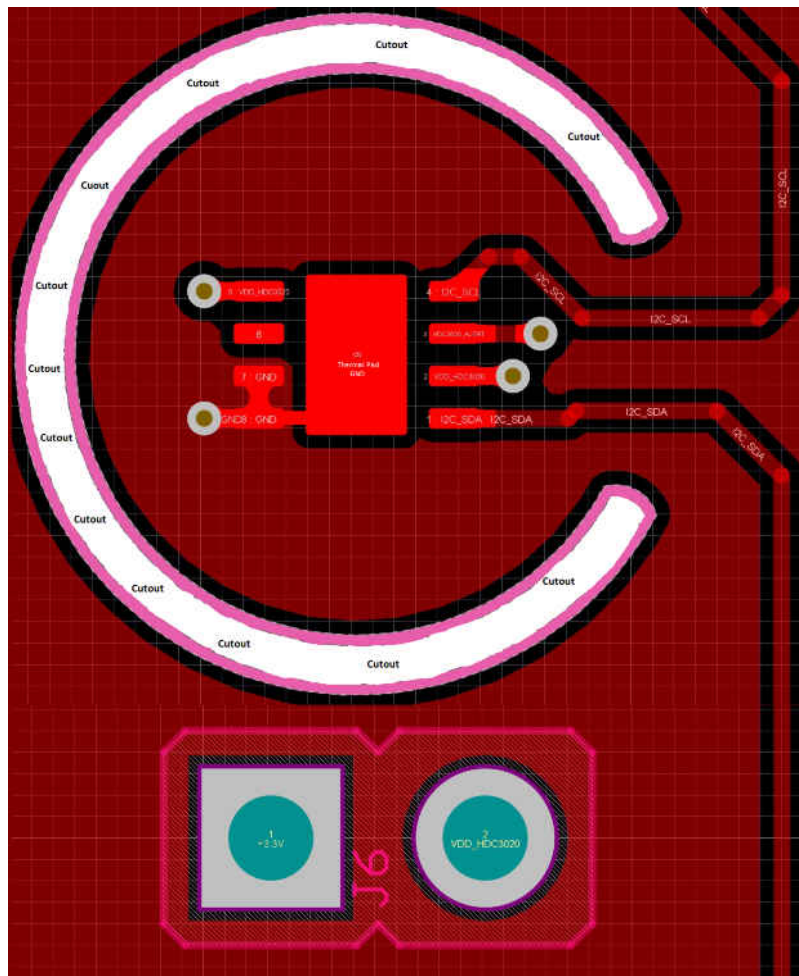

Figure 10-1. HDC302x PCB Layout Example

10.3 Storage and PCB Assembly

10.3.1 Storage and Handling

As with all humidity sensors, the HDC302x must follow special guidelines regarding handling and storage that are not common with standard semiconductor devices. Long exposure to UV and visible light, or exposure to chemical vapors for prolonged periods, should be avoided as it may affect RH% accuracy. Additionally, the device should be protected from out-gassed solvent vapors produced during manufacturing, transport, operation, and package materials (that is, adhesive tapes, stickers, bubble foils). For further detailed information, see [HDC3x Silicon User's Guide](#) (SNAU265)

10.3.2 Soldering Reflow

For PCB assembly, standard reflow soldering ovens may be used. The HDC302x uses the standard soldering profile IPC/JEDEC J-STD-020 with peak temperatures at 260°C. When soldering the HDC302x, it is mandatory

to use *no-clean* solder paste, and the paste must not be exposed to water or solvent rinses during assembly because these contaminants may affect sensor accuracy. After reflow, it is expected that the sensor will generally output a shift in relative humidity, which will reduce over time as the sensor is exposed to typical indoor ambient conditions. These conditions include 30-40% RH at room temperature during a duration of several days. Following this rehydration procedure allows the polymer to correctly settle after reflow and return to the calibrated RH accuracy.

10.3.3 Rework

TI recommends to limit the HDC302x to a single IR reflow with no rework, but a second reflow may be possible if the following guidelines are met:

- The exposed polymer (humidity sensor) is kept clean and undamaged.
- No-clean solder paste is used and the process is not exposed to any liquids, such as water or solvents.
- The peak soldering temperature does not exceed 260°C.

10.3.4 Exposure to High Temperature and High Humidity Conditions

Long exposure outside the recommended operating conditions may temporarily offset the RH output. The recommended humidity operating range is 10 to 90% RH (non-condensing) over -20°C to 70°C. Prolonged operation beyond these ranges may shift the sensor reading with a slow recovery time.

10.3.5 Bake/Rehydration Procedure

Prolonged exposure to extreme conditions or harsh contaminants may impact sensor performance. In the case that permanent offset is observed from contaminants, the following procedure is suggested, which may recover or reduce the error observed in sensor performance:

1. Baking: 100°C, at less than 5%RH, for 5 to 10 hours
2. Rehydration: Between 20°C to 30°C, 60%RH to 75%RH, for 6 to 12 hours

11 Device and Documentation Support

11.1 Documentation Support

11.1.1 Related Documentation

For related documentation, see the following:

- Texas Instruments, [Humidity Sensor: Storage and Handling Guidelines application report](#) (SNIA025)
- Texas Instruments, [Optimizing Placement and Routing for Humidity Sensors application report](#) (SNAA297)
- Texas Instruments, [HDC3x Silicon User's Guide](#) (SNAU265)

11.2 Receiving Notification of Documentation Updates

To receive notification of documentation updates, navigate to the device product folder on [ti.com](#). Click on *Subscribe to updates* to register and receive a weekly digest of any product information that has changed. For change details, review the revision history included in any revised document.

11.3 Support Resources

[TI E2E™ support forums](#) are an engineer's go-to source for fast, verified answers and design help — straight from the experts. Search existing answers or ask your own question to get the quick design help you need.

Linked content is provided "AS IS" by the respective contributors. They do not constitute TI specifications and do not necessarily reflect TI's views; see TI's [Terms of Use](#).

11.4 Trademarks

TI E2E™ is a trademark of Texas Instruments.

All trademarks are the property of their respective owners.

11.5 Electrostatic Discharge Caution



This integrated circuit can be damaged by ESD. Texas Instruments recommends that all integrated circuits be handled with appropriate precautions. Failure to observe proper handling and installation procedures can cause damage.

ESD damage can range from subtle performance degradation to complete device failure. Precision integrated circuits may be more susceptible to damage because very small parametric changes could cause the device not to meet its published specifications.

11.6 Glossary

[TI Glossary](#) This glossary lists and explains terms, acronyms, and definitions.

12 Mechanical, Packaging, and Orderable Information

The following pages include mechanical, packaging, and orderable information. This information is the most current data available for the designated devices. This data is subject to change without notice and revision of this document. For browser-based versions of this data sheet, refer to the left-hand navigation.

DEF0008A  **PACKAGE OUTLINE**
WSON - 0.8 mm max height
PLASTIC SMALL OUTLINE - NO LEAD

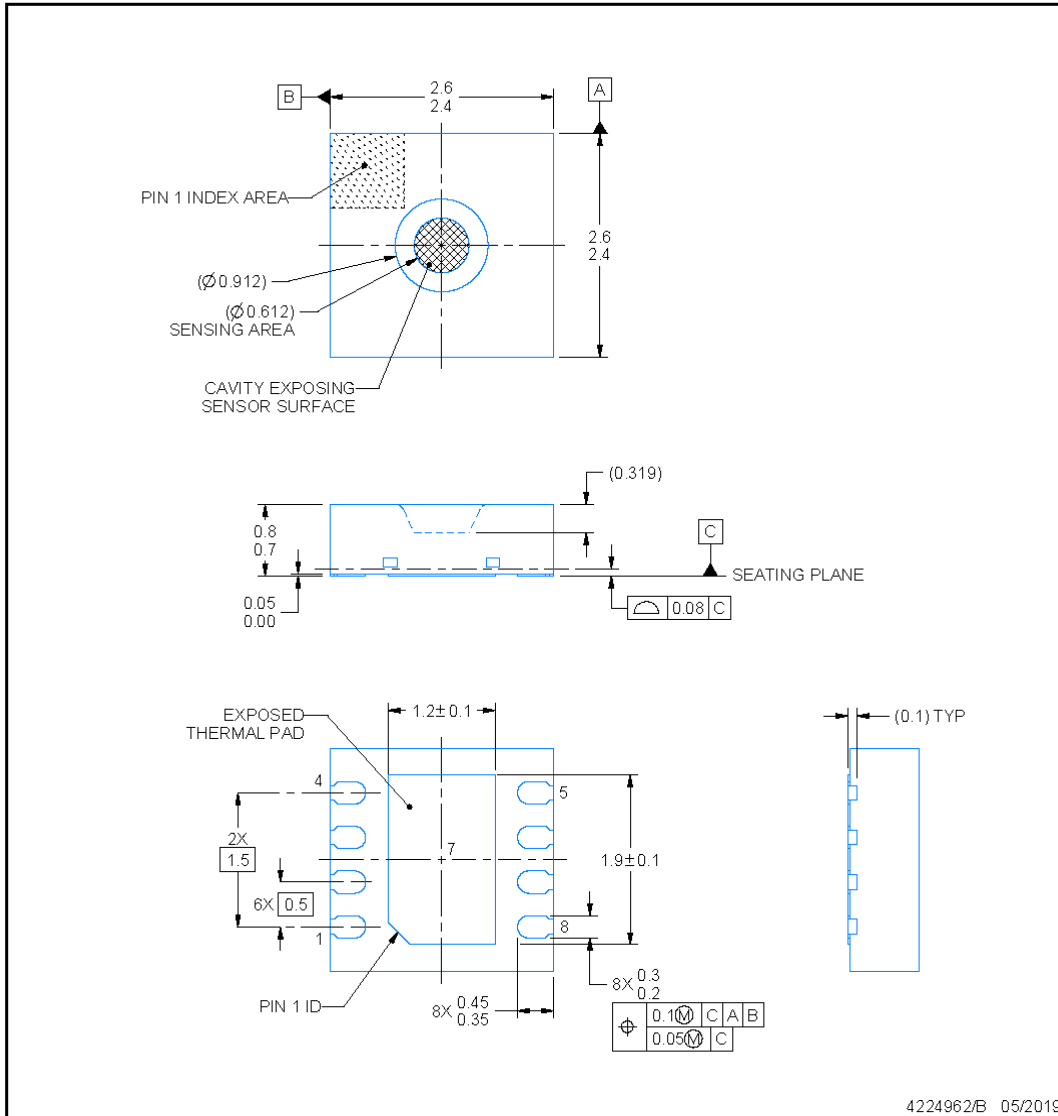

NOTES:

1. All linear dimensions are in millimeters. Any dimensions in parenthesis are for reference only. Dimensioning and tolerancing per ASME Y14.5M.
2. This drawing is subject to change without notice.
3. The package thermal pad must be soldered to the printed circuit board for thermal and mechanical performance.
4. The pick and place nozzle has to be between $\varnothing 0.915$ and $\varnothing 1.875$ mm.

Figure 12-1. HDC3020 Package Outline Drawing

EXAMPLE BOARD LAYOUT

DEF0008A

WSO - 0.8 mm max height

PLASTIC SMALL OUTLINE - NO LEAD

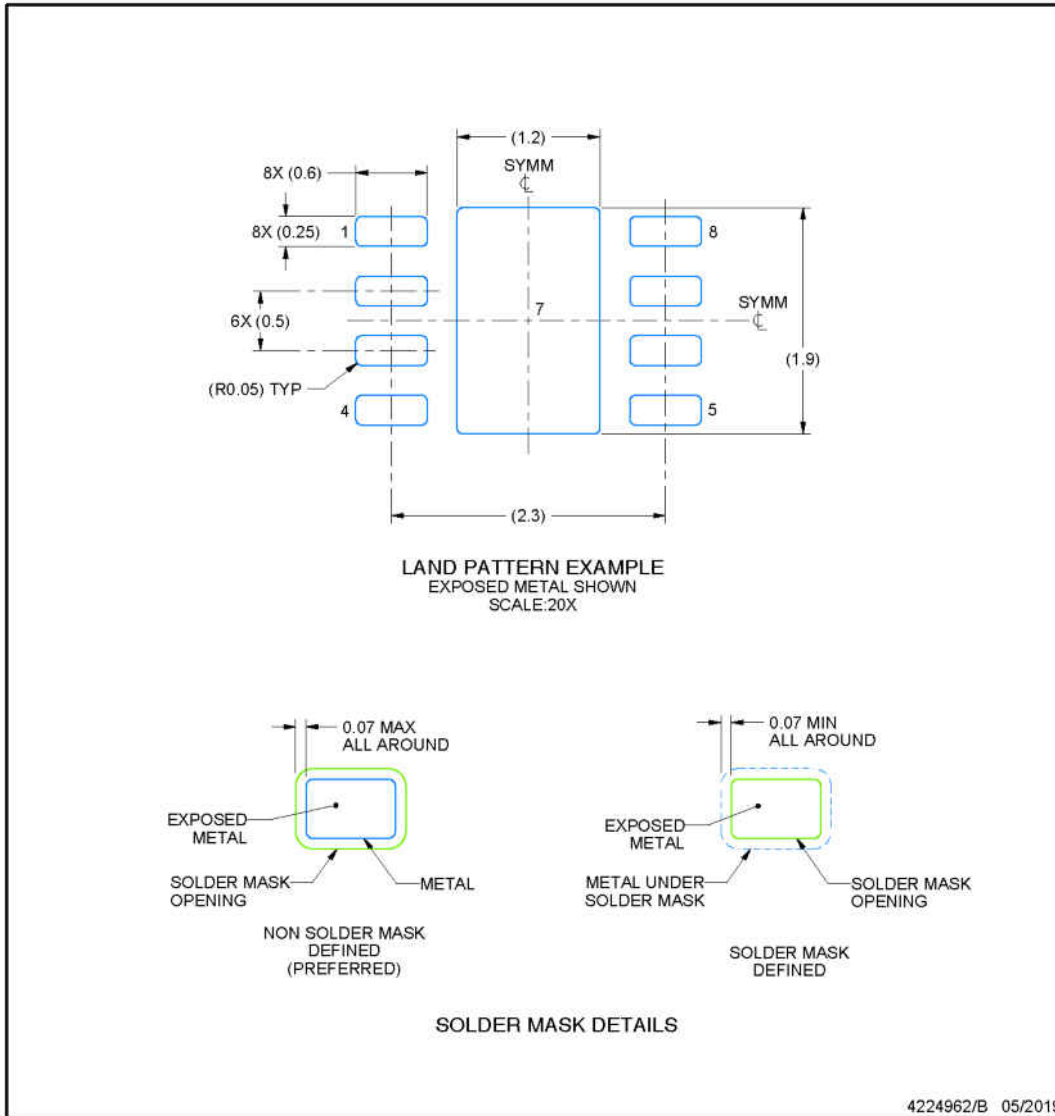

NOTES: (continued)

5. This package is designed to be soldered to a thermal pad on the board. For more information, see Texas Instruments literature number SLUA271 (www.ti.com/lit/sluea271).
6. Vias are optional depending on application, refer to device data sheet. If any vias are implemented, refer to their locations shown on this view. It is recommended that vias under paste be filled, plugged or tented.

Figure 12-2. HDC3020 Example Board Layout

EXAMPLE STENCIL DESIGN

DEF0008A

WSON - 0.8 mm max height

PLASTIC SMALL OUTLINE - NO LEAD

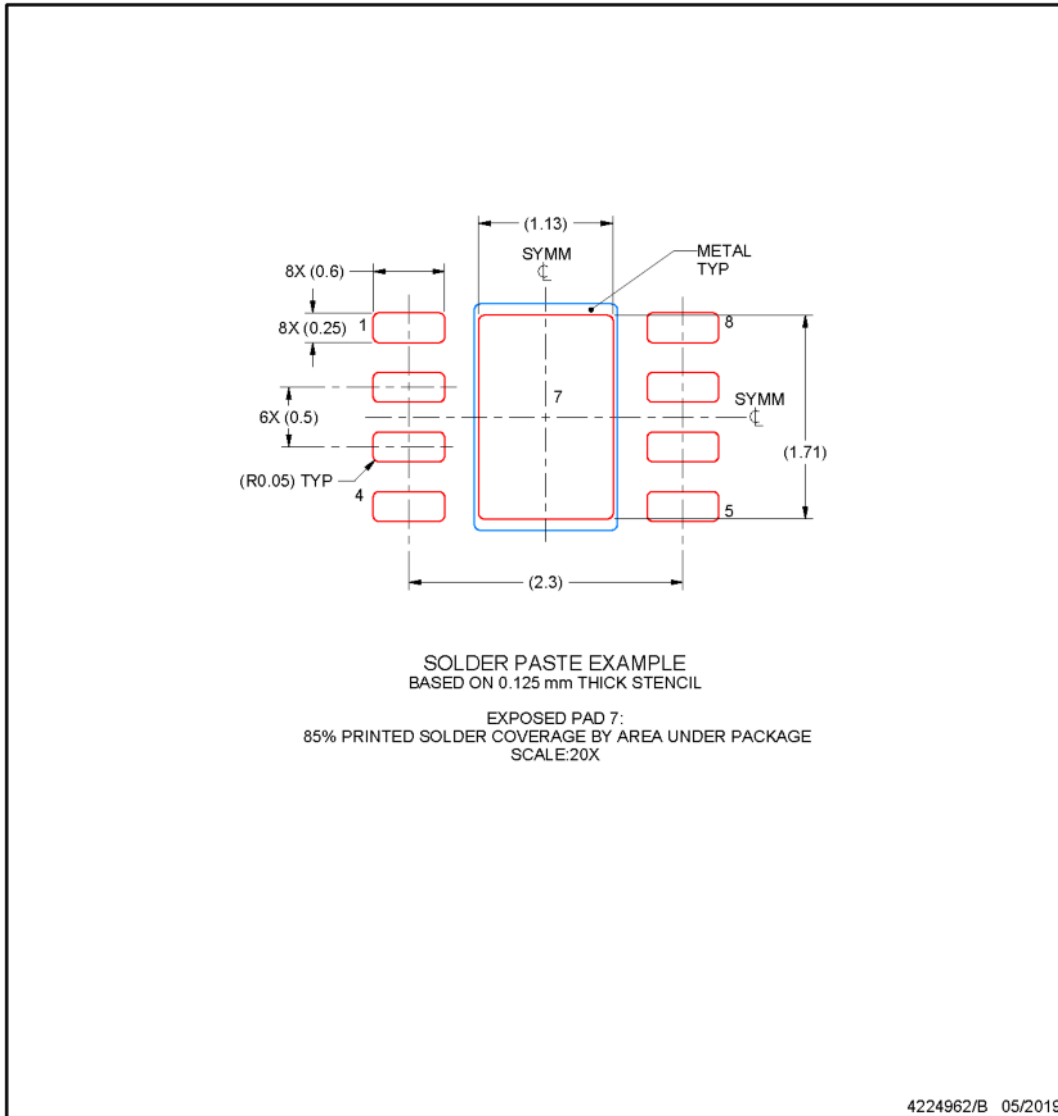

NOTES: (continued)

7. Laser cutting apertures with trapezoidal walls and rounded corners may offer better paste release. IPC-7525 may have alternate design recommendations.

Figure 12-3. HDC3020 Example Stencil Design

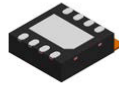

DEH0008A

PACKAGE OUTLINE

WSO - 0.94 mm max height

PLASTIC SMALL OUTLINE - NO LEAD

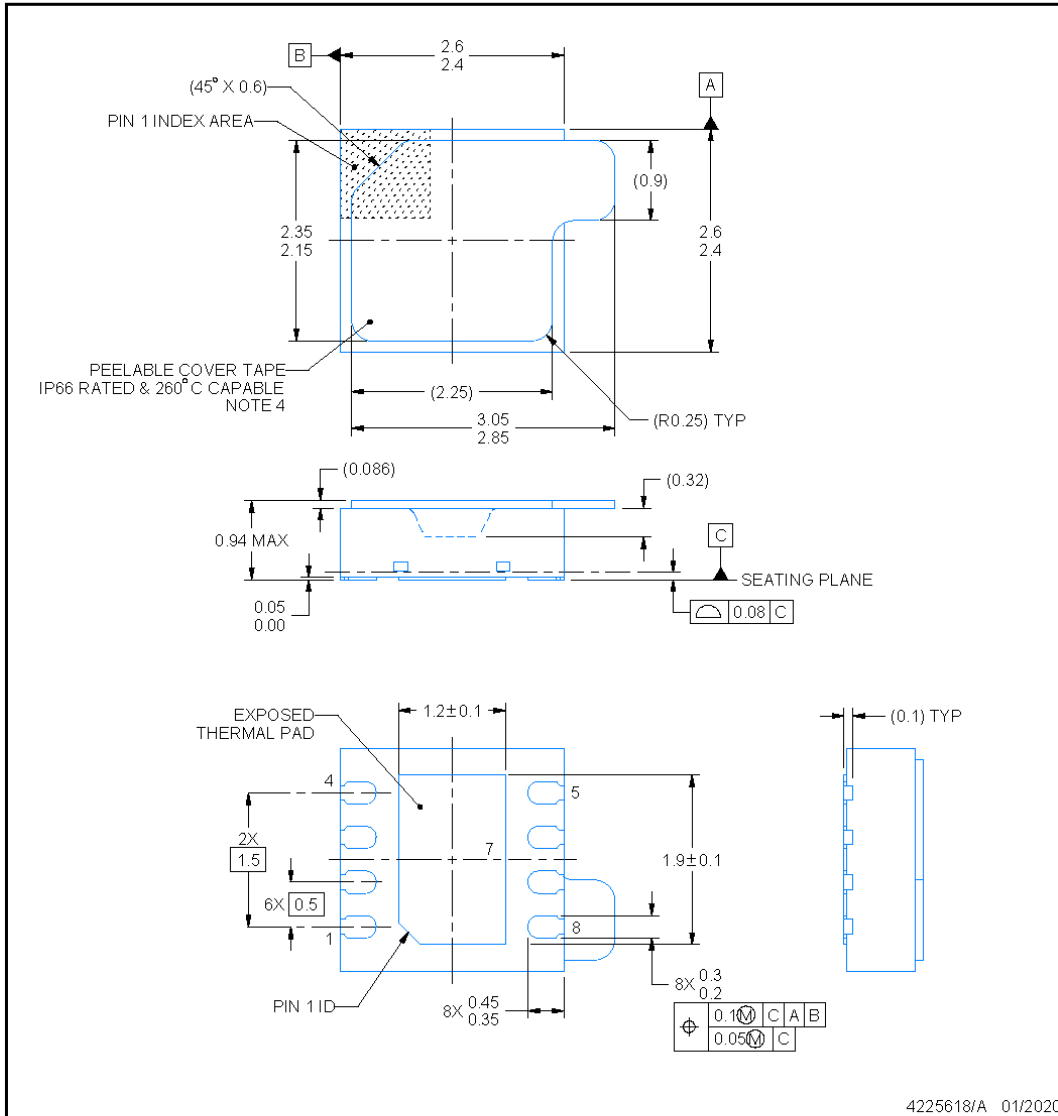

NOTES:

1. All linear dimensions are in millimeters. Any dimensions in parenthesis are for reference only. Dimensioning and tolerancing per ASME Y14.5M.
2. This drawing is subject to change without notice.
3. The package thermal pad must be soldered to the printed circuit board for thermal and mechanical performance.
4. IPXY Rating represents environmental ingress protection from both dust and high pressure water sprays. X=6 represents resistance to dust and Y=6 represents high pressure water spray resistance per IEC60529 testing conditions.

Figure 12-4. HDC3020 Package Outline Drawing

EXAMPLE BOARD LAYOUT

DEH0008A

WSO - 0.94 mm max height

PLASTIC SMALL OUTLINE - NO LEAD

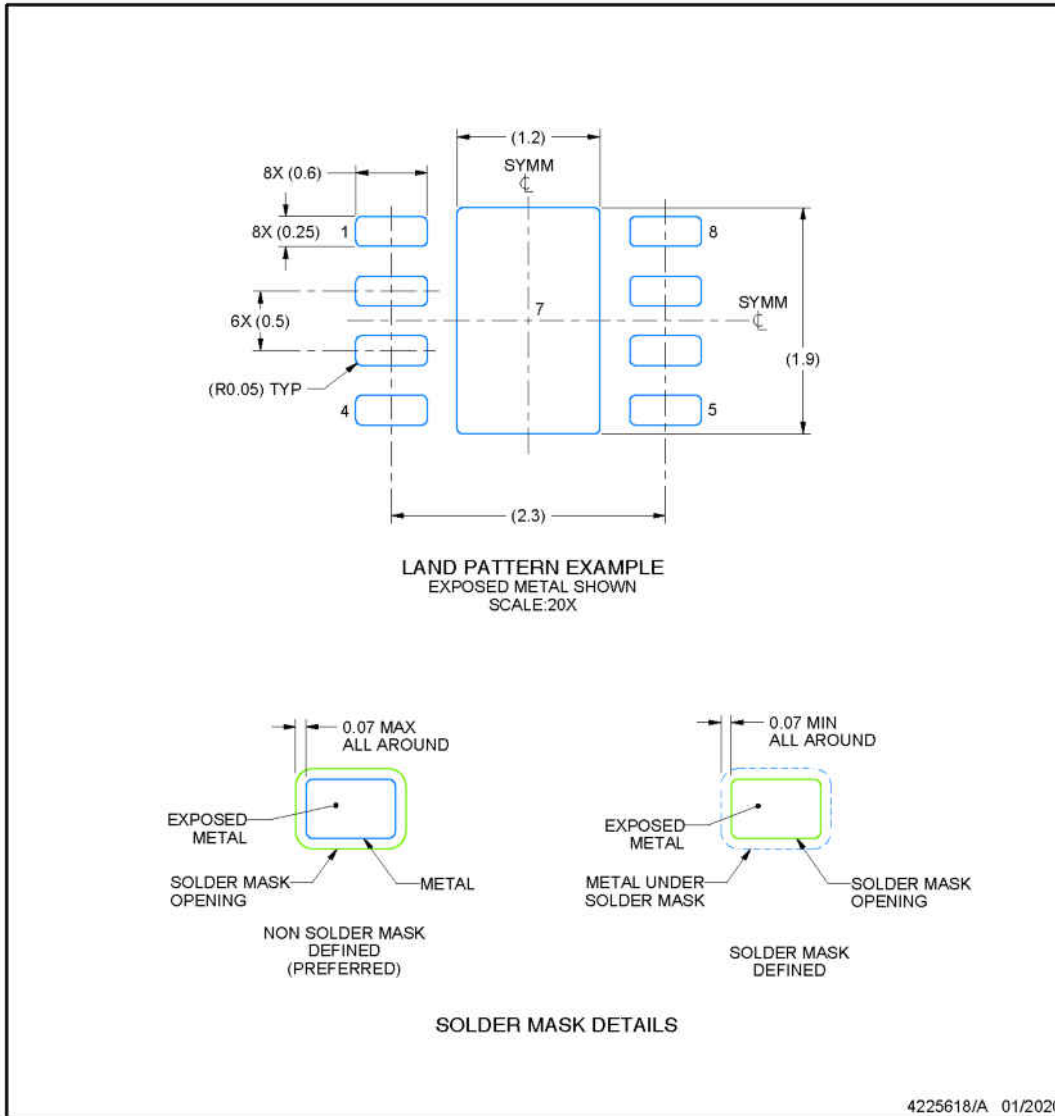

NOTES: (continued)

5. This package is designed to be soldered to a thermal pad on the board. For more information, see Texas Instruments literature number SLUA271 (www.ti.com/lit/slua271).
6. Vias are optional depending on application, refer to device data sheet. If any vias are implemented, refer to their locations shown on this view. It is recommended that vias under paste be filled, plugged or tented.

Figure 12-5. HDC3021 Example Board Layout

EXAMPLE STENCIL DESIGN

DEH0008A

WSON - 0.94 mm max height

PLASTIC SMALL OUTLINE - NO LEAD

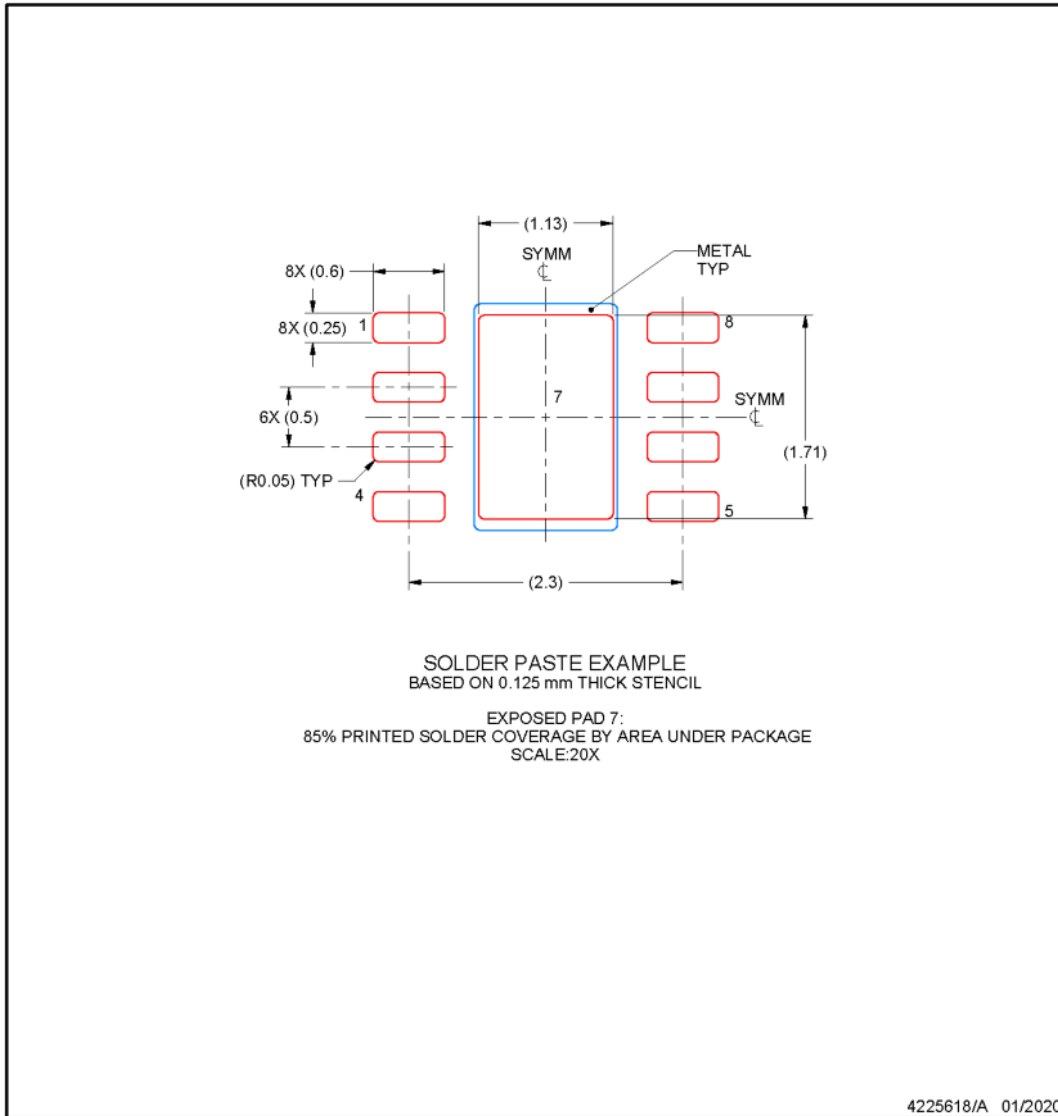

NOTES: (continued)

- 7. Laser cutting apertures with trapezoidal walls and rounded corners may offer better paste release. IPC-7525 may have alternate design recommendations.

ADVANCE INFORMATION

Figure 12-6. HDC3021 Example Stencil Design

HDC3021

ADVANCE INFORMATION



DEJ0008A

PACKAGE OUTLINE
WSO - 1.15 mm max height

PLASTIC SMALL OUTLINE - NO LEAD

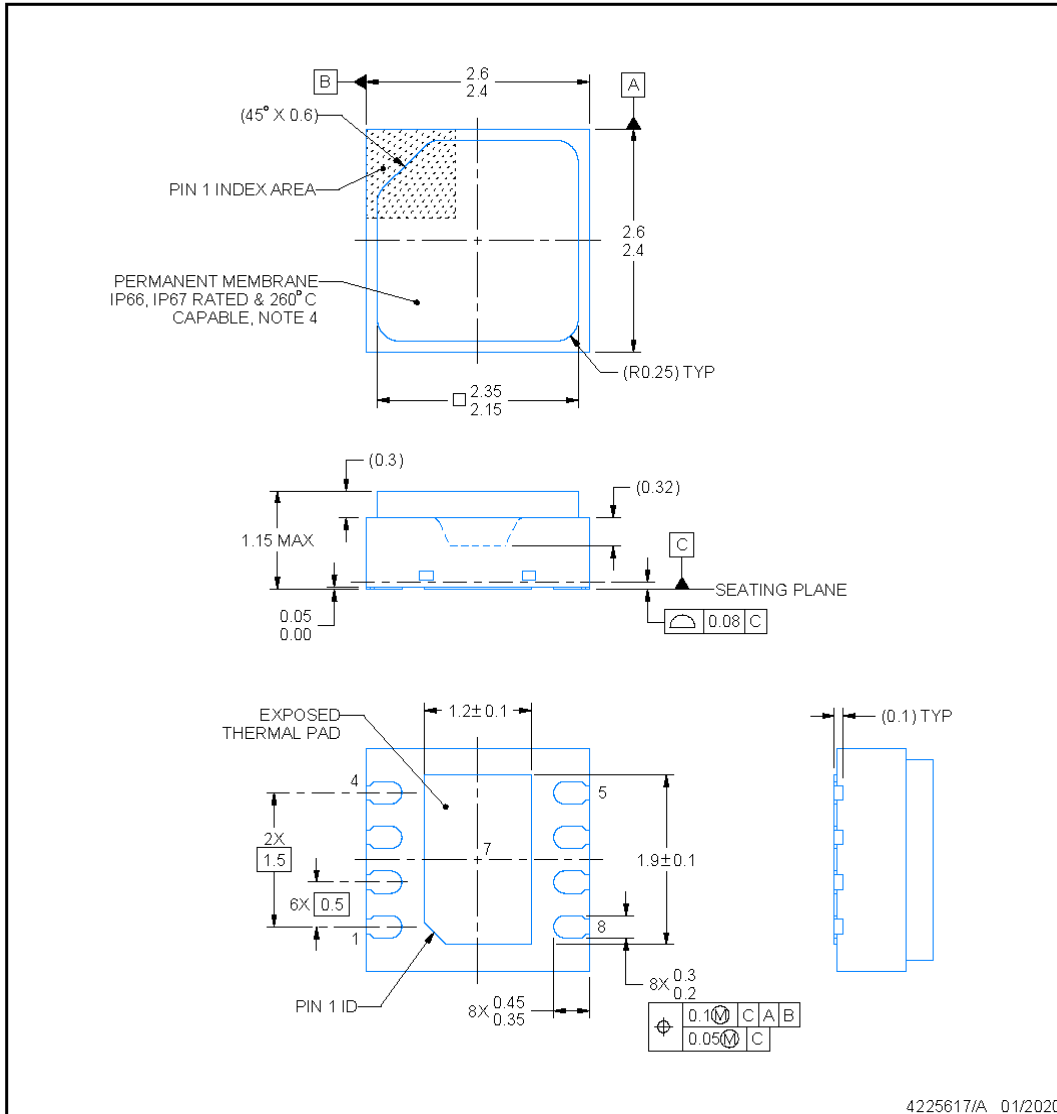

NOTES:

1. All linear dimensions are in millimeters. Any dimensions in parenthesis are for reference only. Dimensioning and tolerancing per ASME Y14.5M.
2. This drawing is subject to change without notice.
3. The package thermal pad must be soldered to the printed circuit board for thermal and mechanical performance.
4. IPXY Rating represents environmental ingress protection from both dust and high pressure water sprays. X=6 represents resistance to dust, Y=6 represents high pressure water spray resistance and Y=7 allows 1m water submersion per IEC60529 testing conditions.

Figure 12-7. Package Outline Drawing

EXAMPLE BOARD LAYOUT

DEJ0008A

WSON - 1.15 mm max height

PLASTIC SMALL OUTLINE - NO LEAD

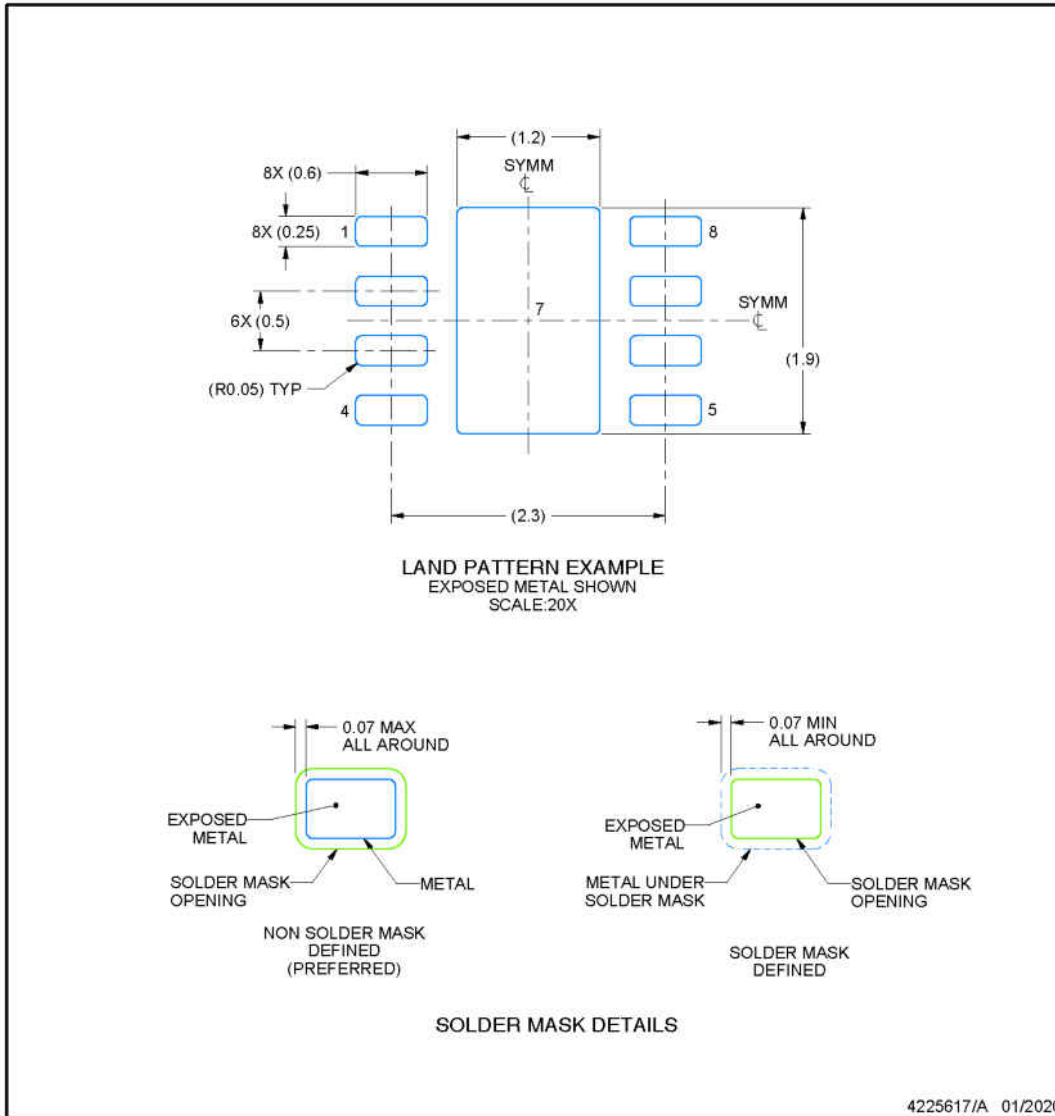

NOTES: (continued)

- This package is designed to be soldered to a thermal pad on the board. For more information, see Texas Instruments literature number SLUA271 (www.ti.com/lit/sluea271).
- Vias are optional depending on application, refer to device data sheet. If any vias are implemented, refer to their locations shown on this view. It is recommended that vias under paste be filled, plugged or tented.

Figure 12-8. HDC3022 Example Board Layout

EXAMPLE STENCIL DESIGN

DEJ0008A

WSO - 1.15 mm max height

PLASTIC SMALL OUTLINE - NO LEAD

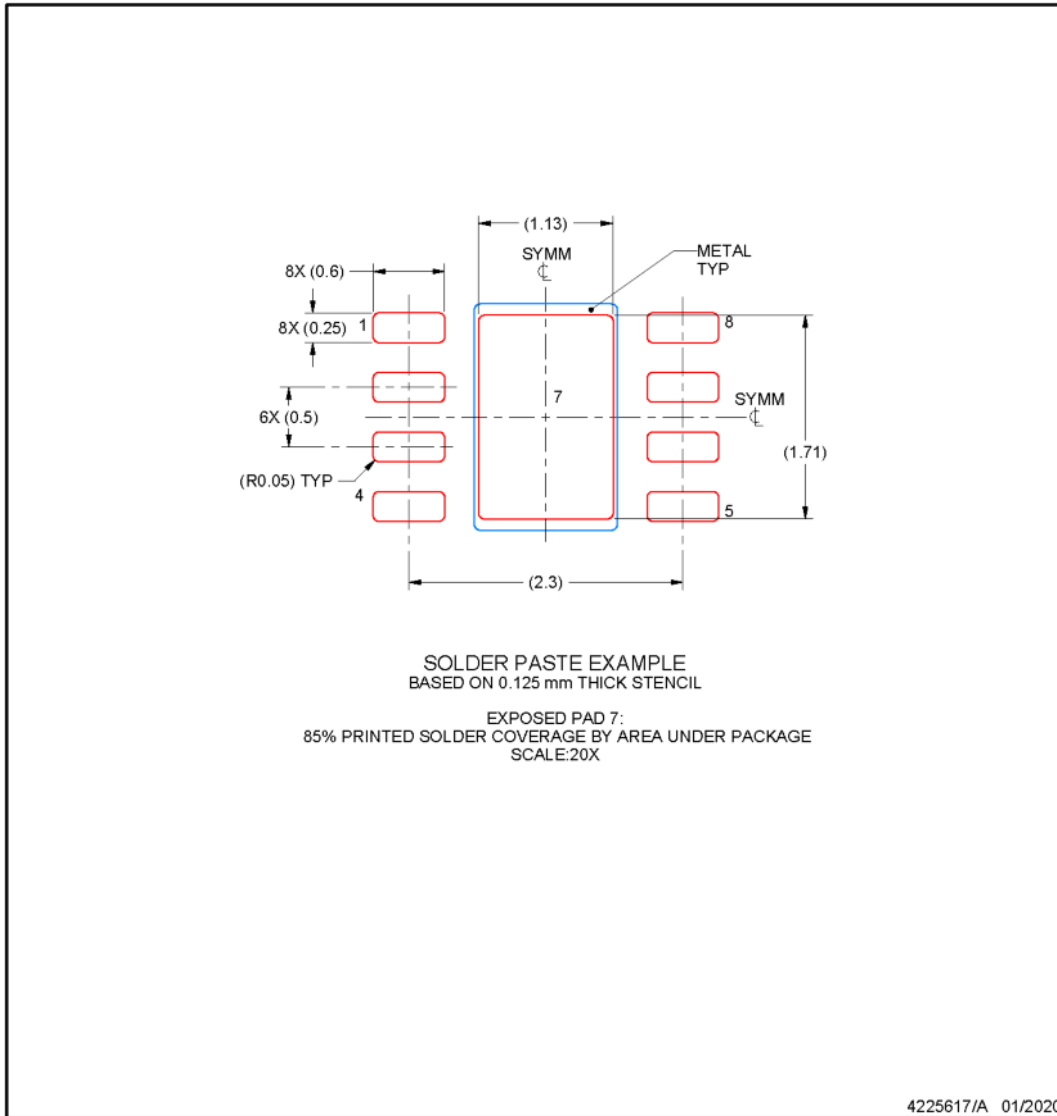

NOTES: (continued)

7. Laser cutting apertures with trapezoidal walls and rounded corners may offer better paste release. IPC-7525 may have alternate design recommendations.

Figure 12-9. HDC3022 Example Stencil Design

12.1 Package Option Addendum

Packaging Information

Orderable Device	Status ⁽¹⁾	Package Type	Package Drawing	Pins	Package Qty	Eco Plan ⁽²⁾	Lead/Ball Finish ⁽⁶⁾	MSL Peak Temp ⁽³⁾	Op Temp (°C)	Device Marking ^{(4) (5)}
PHDC3020DEFT	ACTIVE	WSON	DEF	8	250	RoHS & Green	NIPDAU	Level-1-260C-UNLIM	-40°C to 125°C	G
PHDC3021DEHT	PREVIEW	WSON	DEH	8	250	RoHS & Green	NIPDAU		-40°C to 125°C	H
PHDC3022DEJT	PREVIEW	WSON	DEJ	8	250	RoHS & Green	NIPDAU	Level-1-260C-UNLIM	-40°C to 125°C	J
HDC3020DEFRT	PRE_PROD	WSON	DEF	8	3000	RoHS & Green	NIPDAU	Level-1-260C-UNLIM	-40°C to 125°C	G
HDC3020DEFT	PRE_PROD	WSON	DEF	8	250	RoHS & Green	NIPDAU	Level-1-260C-UNLIM	-40°C to 125°C	G
HDC3021DEHR	PRE_PROD	WSON	DEH	8	3000	RoHS & Green	NIPDAU	Level-1-260C-UNLIM	-40°C to 125°C	H
HDC3021DEHT	PRE_PROD	WSON	DEH	8	250	RoHS & Green	NIPDAU	Level-1-260C-UNLIM	-40°C to 125°C	H
HDC3022DEJRT	PRE_PROD	WSON	DEJ	8	3000	RoHS & Green	NIPDAU	Level-1-260C-UNLIM	-40°C to 125°C	J
HDC3022DEJRT	PRE_PROD	WSON	DEJ	8	250	RoHS & Green	NIPDAU	Level-1-260C-UNLIM		J

- (1) The marketing status values are defined as follows:
ACTIVE: Product device recommended for new designs.
LIFEBUY: TI has announced that the device will be discontinued, and a lifetime-buy period is in effect.
NRND: Not recommended for new designs. Device is in production to support existing customers, but TI does not recommend using this part in a new design.
PRE_PROD Unannounced device, not in production, not available for mass market, nor on the web, samples not available.
PREVIEW: Device has been announced but is not in production. Samples may or may not be available.
OBSOLETE: TI has discontinued the production of the device.
- (2) Eco Plan - The planned eco-friendly classification: Pb-Free (RoHS), Pb-Free (RoHS Exempt), or Green (RoHS & no Sb/Br) - please check www.ti.com/productcontent for the latest availability information and additional product content details.
TBD: The Pb-Free/Green conversion plan has not been defined.
Pb-Free (RoHS): TI's terms "Lead-Free" or "Pb-Free" mean semiconductor products that are compatible with the current RoHS requirements for all 6 substances, including the requirement that lead not exceed 0.1% by weight in homogeneous materials. Where designed to be soldered at high temperatures, TI Pb-Free products are suitable for use in specified lead-free processes.
Pb-Free (RoHS Exempt): This component has a RoHS exemption for either 1) lead-based flip-chip solder bumps used between the die and package, or 2) lead-based die adhesive used between the die and leadframe. The component is otherwise considered Pb-Free (RoHS compatible) as defined above.
Green (RoHS & no Sb/Br): TI defines "Green" to mean Pb-Free (RoHS compatible), and free of Bromine (Br) and Antimony (Sb) based flame retardants (Br or Sb do not exceed 0.1% by weight in homogeneous material).
- (3) MSL, Peak Temp. -- The Moisture Sensitivity Level rating according to the JEDEC industry standard classifications, and peak solder temperature.
- (4) There may be additional marking, which relates to the logo, the lot trace code information, or the environmental category on the device.

- (5) Multiple Device markings will be inside parentheses. Only one Device Marking contained in parentheses and separated by a "~" will appear on a device. If a line is indented then it is a continuation of the previous line and the two combined represent the entire Device Marking for that device.
- (6) Lead/Ball Finish - Orderable Devices may have multiple material finish options. Finish options are separated by a vertical ruled line. Lead/Ball Finish values may wrap to two lines if the finish value exceeds the maximum column width.

Important Information and Disclaimer: The information provided on this page represents TI's knowledge and belief as of the date that it is provided. TI bases its knowledge and belief on information provided by third parties, and makes no representation or warranty as to the accuracy of such information. Efforts are underway to better integrate information from third parties. TI has taken and continues to take reasonable steps to provide representative and accurate information but may not have conducted destructive testing or chemical analysis on incoming materials and chemicals. TI and TI suppliers consider certain information to be proprietary, and thus CAS numbers and other limited information may not be available for release.

In no event shall TI's liability arising out of such information exceed the total purchase price of the TI part(s) at issue in this document sold by TI to Customer on an annual basis.

12.2 Tape and Reel Information

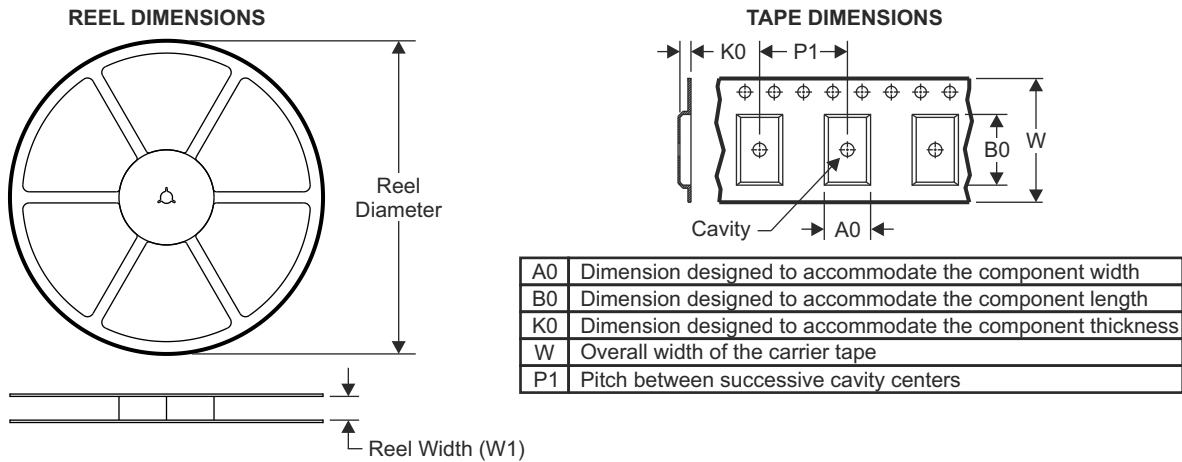

QUADRANT ASSIGNMENTS FOR PIN 1 ORIENTATION IN TAPE

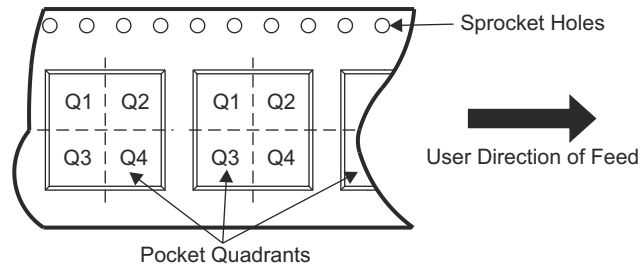

Device	Package Type	Package Drawing	Pins	SPQ	Reel Diameter (mm)	Reel Width W1 (mm)	A0 (mm)	B0 (mm)	K0 (mm)	P1 (mm)	W (mm)	Pin1 Quadrant
PHDC3020DEFT	WSON	DEF	8	250	178	12	2.75	2.75	1.3	8	12	2
PHDC3021DEFT	WSON	DEH	8	250	178	12	2.75	2.75	1.3	8	12	2
PHDC3022DEFT	WSON	DEJ	8	250	178	12	2.75	2.75	1.3	8	12	2
HDC3020DEFR	WSON	DEF	8	3000	60	12	2.75	2.75	1.3	8	12	2
HDC3020DEFT	WSON	DEF	8	250	178	12	2.75	2.75	1.3	8	12	2
HDC3021DEHR	WSON	DEH	8	3000	60	12	2.8	2.8	1.1	8	12	2
HDC3021DEHT	WSON	DEH	8	250	178	12	2.8	2.8	1.1	8	12	2
HDC3022DEJR	WSON	DEJ	8	3000	60	12	2.75	2.75	1.3	8	12	2
HDC3022DEJT	WSON	DEJ	8	250	178	12	2.75	2.75	1.3	8	12	2

TAPE AND REEL BOX DIMENSIONS

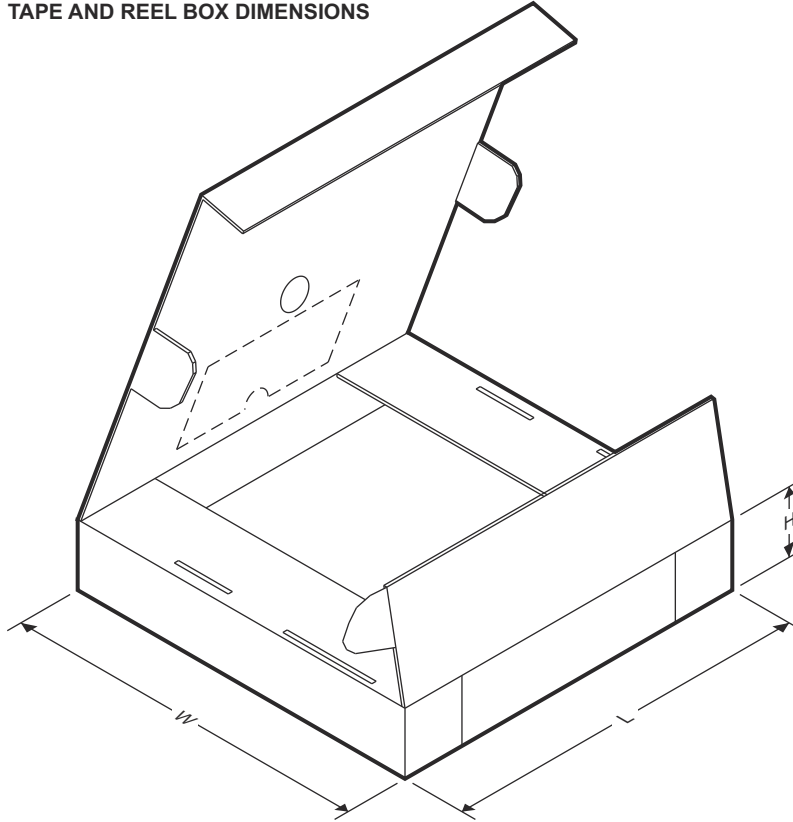

ADVANCE INFORMATION

Device	Package Type	Package Drawing	Pins	SPQ	Length (mm)	Width (mm)	Height (mm)
PHDC3020DEFT	WSO	DEF	8	250	193	193	70
PHDC3021DEFT	WSO	DEF	8	250	193	193	70
PHDC3022DEFT	WSO	DEF	8	250	193	193	70
HDC3020DEFR	WSO	DEF	8	3000	193	193	70
HDC3020DEFT	WSO	DEF	8	250	193	193	70
HDC3021DEHR	WSO	DEH	8	3000	193	193	70
HDC3021DEHT	WSO	DEH	8	250	193	193	70
HDC3022DEJR	WSO	DEJ	8	3000	193	193	70
HDC3022DEJT	WSO	DEJ	8	250	193	193	70

PACKAGING INFORMATION

Orderable Device	Status (1)	Package Type	Package Drawing	Pins	Package Qty	Eco Plan (2)	Lead finish/ Ball material (6)	MSL Peak Temp (3)	Op Temp (°C)	Device Marking (4/5)	Samples
PHDC3020DEFT	ACTIVE	WSON	DEF	8	250	Non-RoHS & Non-Green	Call TI	Call TI	-40 to 125		

(1) The marketing status values are defined as follows:

ACTIVE: Product device recommended for new designs.

LIFEBUY: TI has announced that the device will be discontinued, and a lifetime-buy period is in effect.

NRND: Not recommended for new designs. Device is in production to support existing customers, but TI does not recommend using this part in a new design.

PREVIEW: Device has been announced but is not in production. Samples may or may not be available.

OBSELETE: TI has discontinued the production of the device.

(2) **RoHS:** TI defines "RoHS" to mean semiconductor products that are compliant with the current EU RoHS requirements for all 10 RoHS substances, including the requirement that RoHS substance do not exceed 0.1% by weight in homogeneous materials. Where designed to be soldered at high temperatures, "RoHS" products are suitable for use in specified lead-free processes. TI may reference these types of products as "Pb-Free".

RoHS Exempt: TI defines "RoHS Exempt" to mean products that contain lead but are compliant with EU RoHS pursuant to a specific EU RoHS exemption.

Green: TI defines "Green" to mean the content of Chlorine (Cl) and Bromine (Br) based flame retardants meet JS709B low halogen requirements of <=1000ppm threshold. Antimony trioxide based flame retardants must also meet the <=1000ppm threshold requirement.

(3) MSL, Peak Temp. - The Moisture Sensitivity Level rating according to the JEDEC industry standard classifications, and peak solder temperature.

(4) There may be additional marking, which relates to the logo, the lot trace code information, or the environmental category on the device.

(5) Multiple Device Markings will be inside parentheses. Only one Device Marking contained in parentheses and separated by a "~" will appear on a device. If a line is indented then it is a continuation of the previous line and the two combined represent the entire Device Marking for that device.

(6) Lead finish/Ball material - Orderable Devices may have multiple material finish options. Finish options are separated by a vertical ruled line. Lead finish/Ball material values may wrap to two lines if the finish value exceeds the maximum column width.

Important Information and Disclaimer:The information provided on this page represents TI's knowledge and belief as of the date that it is provided. TI bases its knowledge and belief on information provided by third parties, and makes no representation or warranty as to the accuracy of such information. Efforts are underway to better integrate information from third parties. TI has taken and continues to take reasonable steps to provide representative and accurate information but may not have conducted destructive testing or chemical analysis on incoming materials and chemicals. TI and TI suppliers consider certain information to be proprietary, and thus CAS numbers and other limited information may not be available for release.

In no event shall TI's liability arising out of such information exceed the total purchase price of the TI part(s) at issue in this document sold by TI to Customer on an annual basis.

OTHER QUALIFIED VERSIONS OF HDC3020 :

- Automotive : [HDC3020-Q1](#)

NOTE: Qualified Version Definitions:

- Automotive - Q100 devices qualified for high-reliability automotive applications targeting zero defects

IMPORTANT NOTICE AND DISCLAIMER

TI PROVIDES TECHNICAL AND RELIABILITY DATA (INCLUDING DATASHEETS), DESIGN RESOURCES (INCLUDING REFERENCE DESIGNS), APPLICATION OR OTHER DESIGN ADVICE, WEB TOOLS, SAFETY INFORMATION, AND OTHER RESOURCES "AS IS" AND WITH ALL FAULTS, AND DISCLAIMS ALL WARRANTIES, EXPRESS AND IMPLIED, INCLUDING WITHOUT LIMITATION ANY IMPLIED WARRANTIES OF MERCHANTABILITY, FITNESS FOR A PARTICULAR PURPOSE OR NON-INFRINGEMENT OF THIRD PARTY INTELLECTUAL PROPERTY RIGHTS.

These resources are intended for skilled developers designing with TI products. You are solely responsible for (1) selecting the appropriate TI products for your application, (2) designing, validating and testing your application, and (3) ensuring your application meets applicable standards, and any other safety, security, or other requirements. These resources are subject to change without notice. TI grants you permission to use these resources only for development of an application that uses the TI products described in the resource. Other reproduction and display of these resources is prohibited. No license is granted to any other TI intellectual property right or to any third party intellectual property right. TI disclaims responsibility for, and you will fully indemnify TI and its representatives against, any claims, damages, costs, losses, and liabilities arising out of your use of these resources.

TI's products are provided subject to TI's Terms of Sale (<https://www.ti.com/legal/termsofsale.html>) or other applicable terms available either on [ti.com](https://www.ti.com) or provided in conjunction with such TI products. TI's provision of these resources does not expand or otherwise alter TI's applicable warranties or warranty disclaimers for TI products.

Mailing Address: Texas Instruments, Post Office Box 655303, Dallas, Texas 75265
Copyright © 2021, Texas Instruments Incorporated